

CATALOG | SEPTEMBER 2021

Low voltage

Motors for explosive dust atmospheres

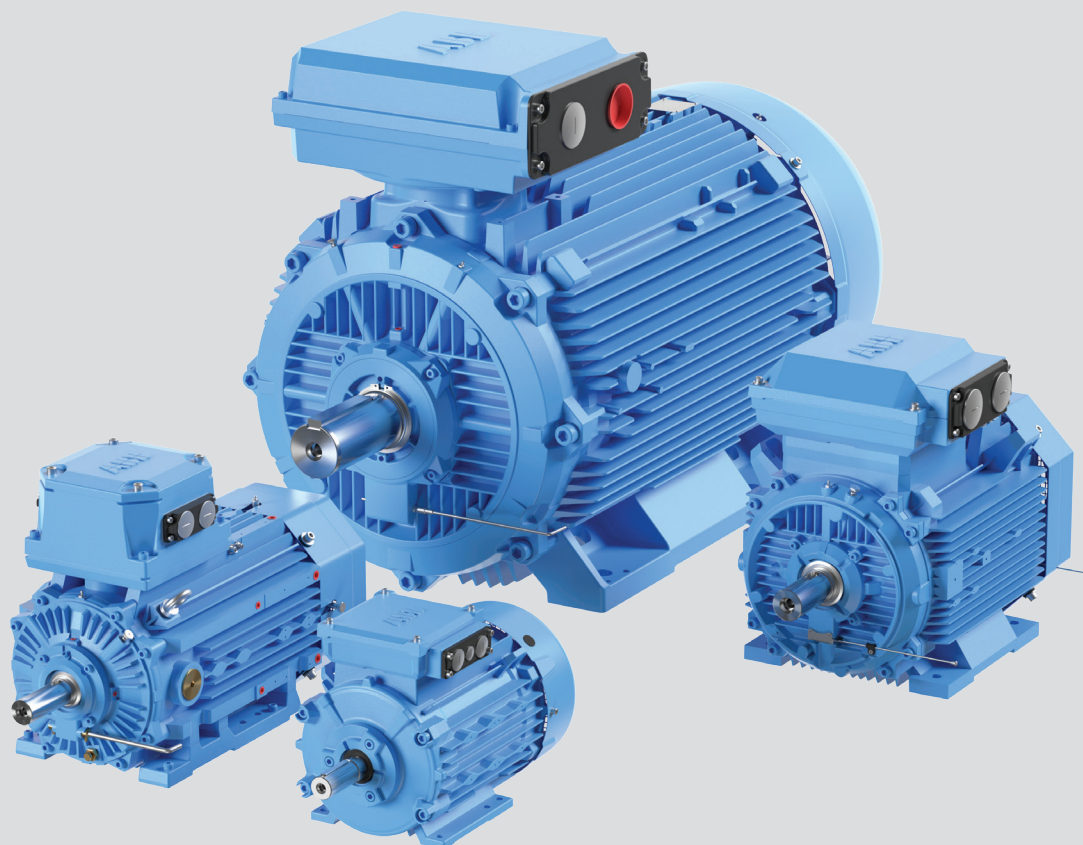

With expertise, and a comprehensive portfolio of products and life-cycle services, we help value-minded industrial customers improve their energy efficiency and productivity.

Low voltage motors for explosive dust atmospheres

4	General information
14	Mounting arrangements
15	Voltage and frequency
16	Cooling
17	Degrees of protection
18	Insulation
19	Surface treatment
20	Low voltage motors and frequency converters for explosive atmospheres
28	Dust ignition protection cast iron motors
28	Ordering information
29	Rating plates
30	Technical data
45	Variant codes
50	Mechanical design
62	Terminal box
71	Dimension drawings
74	Motors in brief
78	Dust ignition protection aluminum motors
78	Ordering information
79	Rating plates
80	Technical data
95	Variant codes
99	Mechanical design
105	Terminal box
107	Dimension drawings
109	Motors in brief
110	Total product offering
111	ABB's portfolio of drives

General information

European ATEX Directives

The ATEX Directives harmonize safety rules in line with the free trading principles of the European Community.

Responsibilities are split between the manufacturers and end users. Manufacturers have to comply with the “Essential Health and Safety Requirements” of the Products Directive 2014/34/EU and end users must prepare an Explosion Protection Document based on risk assessments of their “work places” and “work equipment” to fulfil the “minimum requirements” listed in the Worker Protection Directive 1999/92/EC.

ABB low voltage motors for explosive atmospheres comply fully with the ATEX Product Directive.

According to the regulations, low voltage motors for explosive atmospheres are exempted from the Low Voltage Directive, the EMC Directive and the Machinery Directive.

IECEX System

The IECEX System is a certification system which verifies compliance with IEC (International Electrotechnical Commission) standards relating to safety in explosive atmospheres. It covers equipment, service facilities and personnel competencies and conformity mark licensing system.

Created in September 1999, the System aims “to facilitate international trade in equipment and services for use in explosive atmospheres, while maintaining the required level of safety...” (source: IECEX website, www.iecex.com). It is a voluntary system which provides an internationally accepted means of proving that products and services are in compliance with IEC standards. The voluntary and international aspects of the IECEX System differentiate it from certification under ATEX, for example, which is mandatory but applies only within the European Economic Area.

The IECEX System comprises global certification programs for both equipment and service facilities.

IECEX certification involves – in addition to product tests - assessment of quality control procedures and testing plans, audits of manufacturing plants, and routine on-going surveillance and inspections.

In addition, IECEX has established a comprehensive set of operational documents and procedures to develop a single internationally standardized approach to Ex testing and certification.



The approach includes:

- A standardized “IECEX way of Ex Testing and Certification”. There is a single set of operational procedures, and Ex test procedures are always applied in the same way.
- A dedicated Technical and Operational Secretariat to maintain operations. Ex test procedures are evaluated and monitored on a centralized basis.

Who is responsible for the certification work?

A manufacturer needing to have equipment certified under the IECEX System can apply to an IECEX Competent Body (ExCB) in any member country. At present there are more than 30 IECEX member countries. The ExCB performs or coordinates the activities of certification.

A quality assessment of the manufacturer is undertaken by the ExCB itself, and the auditor issues an IECEX Quality Assessment Report (QAR).

Type testing of product samples is performed on behalf of the ExCB by an IECEX Assessment and Testing Laboratory (ExTL). On completion of its work the ExTL’s assessment engineer prepares an IECEX Test Report (ExTR).

The ExTR is then submitted to the ExCB for endorsement. Based on the QAR and ExTR, the ExCB then issues the Certificate of Conformity (CoC). The CoC provides internationally accepted

verification that the equipment in question is in compliance with the relevant IEC standards. Once formally issued by the ExCB, both the ExTR and QAR are registered on the IECEX Internet site. This provides verification that an ExTR and QAR exist for the product and manufacturer.

How do I know if a motor is IECEX certified?

IECEX certified motors show the certification number on their rating plate, for example: “IECEX LCI 05.0008”. In this case “LCI” indicates that the IECEX certificate was issued by LCIE, an IECEX approved Certification Body in France.

In addition, IECEX certificates are issued in electronic form and are publicly available on the IECEX website. They can therefore be viewed and printed by anyone with access to the Internet. See “Certificates & Licences” at www.iecex.com.

IECEX certification is particularly useful in certain markets. In Australia, New Zealand, and Singapore, for example, IECEX certificates are accepted, but not all IEC certificates are accepted. Certain other countries, including Russia, China and Korea, are prepared to accept ExTRs as a basis for their own national certificates. There are also many countries that are willing to accept products covered by current IECEX certificates, even though the countries in question are not members of the IECEX Management Framework.

IECEX Conformity Mark License

The IECEX Conformity Mark System was introduced in 2008. IECEX Conformity Mark Licenses are issued by approved Certification Bodies in IECEX participating countries.

The IECEX Conformity Mark shows that a product has been granted an IECEX Certificate of Conformity. IECEX Certification confirms that the product has the appropriate protection for use in explosive atmospheres and that it has been manufactured under systems subject to ongoing surveillance by Certification Bodies. It is recognized in all the countries participating in the IECEX System, and it also means that the product can be supplied to the market without the need for additional tests.

ABB has been granted IECEX Certification for a wide range of low and high voltage motors, and these can therefore display the IECEX Conformity Mark. The hazardous area protection types provided by these motors include

- Flameproof Ex d, Ex de
- Non-sparking Ex nA
- Increased safety Ex ec
- Dust protection Ex t

The IECEX Conformity Mark License will considerably enhance ABB’s ability to market its products

globally. It complements ABB’s existing ATEX and other approvals.

Benefits of IECEX System for end users

A significant advantage of IECEX is that vendor certificates are available for inspection on the IECEX website. End users can therefore confirm the validity of IECEX certificates at any time - which is not possible with ATEX, for example. This increases end user confidence that the motor vendor will be committed to maintaining the necessary quality systems.

Under the quality based IECEX certification approach the interpretation of the standard is shared throughout the 30 participating countries and individual interpretations by Notified Bodies are not allowed. Another advantage of IECEX is that the Certificate of Conformity also covers EPL (equipment protection level) “c”, see table on next page.

Which ABB motors and generators are IECEX certified?

All motors listed in this catalogue are IECEX certified, except motor types M3HP and M3AA in frame sizes 71 to 80.

Compliance on basis of recently updated standards

In complying with the ATEX 95 directives, ABB follows the requirements of recently updated IEC and EN standards. Otherwise ABB follows the requirements of the IEC standards shown in the relevant certificates.

Main standards for explosive atmospheres:

IEC/EN 60079-0	Equipment - General requirements
IEC/EN 60079-1	Equipment protection by flameproof enclosures “d”
IEC/EN 60079-7	Equipment protection by increased safety “e”
IEC/EN 60079-15*	Equipment protection by type of protection “n”
IEC/EN 60079-31	Equipment dust ignition protection by enclosure “t”
IEC/EN 60079-14	Electrical installations design, selection and erection
IEC/EN 60079-17	Electrical installations inspections and maintenance
IEC/EN 60079-19	Equipment repair, overhaul and reclamation
IEC 60050-426	Equipment for explosive atmospheres
IEC/EN 60079-10	Classification of hazardous areas (gas areas)
IEC 60079-10-1	Classification of areas - Explosive gas atmospheres
IEC 60079-10-2	Classification of areas - Combustible dust atmospheres

* Moved to IEC/EN 60079-7 in 2015 revision.

Equipment protection levels (EPLs)

The latest revisions of the IEC and EN standards introduce the concept of “equipment protection levels”, which identify products according to the ignition risk they might cause. A motor’s EPL therefore indicates its inherent ignition risk, regardless of its protection type. This makes the selection of equipment for different zones easier. EPLs also enable a true risk assessment approach, where the potential consequences of a possible explosion are taken into consideration. Please refer to the table on the next page for more information about EPLs and EPL markings.

New markings introduced

The latest revisions of the standards IEC/EN 60079-7 and IEC/EN 60079-1 have introduced some new markings for equipment suitable for locations where there is a potential risk of gas present. The non-sparking protection method is no longer used on rotating electrical machines, instead have two levels on increased safety protection been introduced in edition 5 of IEC/EN 60079-7. One higher level of protection with EPL Gb that technically corresponds to the old Ex e, an a new lower level with EPL Gc that corresponds to Ex nA as previously defined in IEC/EN 60079-15.

Further have also several levels of protection been introduced in edition 7 of IEC/EN 60079-1 for flame proof protection. These two changes does affect the markings used both flameproof, increased safety and non-sparking equipment for group II as shown in table below. Product certificates are updated gradually to show new markings, during the transition period may both old and new markings be used in parallel depending type and size of motor.

Old way of marking	Old protection method	New way of marking	New protection method	Zone	ATEX category
Ex nA IIC T3 Gc	Non-sparking	Ex ec IIC T3 Gc	Increased safety	2	3G
Ex d IIB/C T4 Gb	Flameproof	Ex db IIB/C T4 Gb	Unchanged	1 (or 2)	2G
Ex de IIB/C T4 Gb	Flameproof and increased safety	Ex db eb IIB/C T4 Gb	Unchanged	1 (or 2)	2G

Zones - IECEx and ATEX

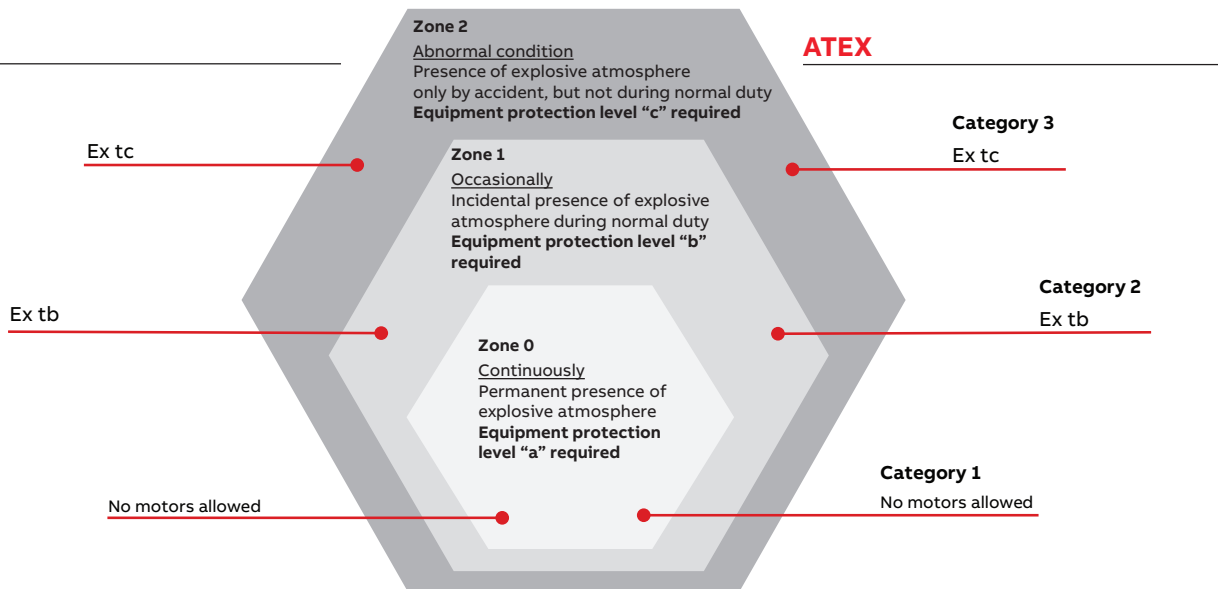

Note: Based on traditional relationship between EPL`s and zones.

There are systems in place worldwide to classify explosive atmospheres by zones, according to the risk posed by explosive gas ("G") or dust ("D").

Classification of explosive atmospheres according to CENELEC and IEC

The following standards define areas according to the presence of gas or dust in the atmosphere:

- IEC/EN 60079-10-1 Gas
- IEC/EN 60079-10-2 Dust

Standard IEC 60079-0 EN 60079-0 Group	EPL	Protection level	Installation Zone acc. to IEC 60079-10-x EN 60079-10-x Zones	ATEX Directive 2014/34/EU Equipment group	Equipment category	Main motor protection types
I (Mines)	Ma	very high	NA	I (Mines)	M1	NA
	Mb	high			M2	
II (Gas)	Ga	very high	0	II (Surface)	1G	NA
	Gb	high	1		2G	Ex d/Ex de Ex p, Ex db, Ex db eb, Ex p, Ex eb (Ex e)
	Gc	enhanced	2		3G	Ex ec (Ex nA)
III Dust	Da	very high	20		1D	NA
	Db	high	21		2D	Ex tb IP 65
	Dc	enhanced	22		3D	Ex tc IP 65/IP 55

Dust ignition protection / Protection by enclosures “t” in explosive atmospheres

Combustible dust is hazardous as it can form potentially explosive atmospheres when dispersed in air. Furthermore, layers of combustible dust may ignite and act as an ignition source for an explosive atmosphere. Explosive atmospheres with dust can be found in a variety of industries such as agriculture, chemicals, plastics, food and beverage.

Selection and installation of electrical equipment

To ensure equipment can be safely used in explosive atmospheres with dust, it is vital that the following issues are taken into account when selecting product:

1. Type of dust:

- Will a cloud of dust be present around the product or
- will a layer of dust build up on the product and if so, what will be the maximum thickness of the layer between two cleaning/maintenance procedures.

2. Characteristics of the dust:

- Is the dust electrically conductive or non-conductive?

3. Ignition temperature of the dust:

- T_{cl} : Ignition temperature of dust in a “cloud” or
- T_{5mm} : Ignition temperature of a 5 mm dust layer

Selection and installation of the product according to IEC/EN60079 part 14: Electrical installations design, selection and erection. Please see the tables below.

Dust classification

		T_{cl} (cloud)°C	T_{5mm} (layer)°C	Surface temperature provided that dust layer below 5 mm
Food/ Feeder industry	Wheat	350	270	195
	Barley, corn	380	280	205
	Sugar	350	430	233
Natural materials	Wood	330	280	205
	Charcoal	520	230	195
	Hard coal	460	240	165
Chemicals	PVC	450	330	255
	Synch, rubber	470	220	145
	Sulfur	240	250	160

Source BIA-report 13/97 HVBG

This protection prevents any explosion of dust because:

- The ingress of dust into the motor is prevented by the IP protection, being either IP 55 (“dust protected”) or IP 65 (“dust tight”).
- The maximum surface temperature outside the motor must not exceed the temperature class for which the motor is certified.
- No sparks must occur outside the motor enclosure.

Certification: Ex tb IIIB/C T...°C Db (for zone 21) motors are certified according to ATEX with an EC type examination certificate and according to the IEC Ex System. Ex tc IIIB/C T...°C Dc (for zone 22) motors are certified according to ATEX with a “voluntary type examination certificate” and according to the IEC Ex System.

The standard surface temperature class on dust ignition protection motors from ABB is T125 °C, other temperature classes are available on request.

Dust subdivisions

IIIA	combustible flyings
IIIB	non-conductive dust
IIIC	conductive dust

Marking of equipment protection for dust according to ATEX

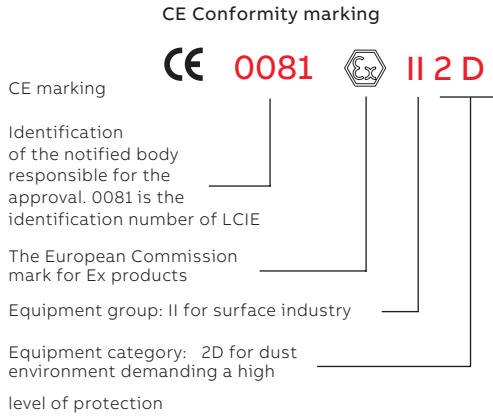

Marking of equipment protection for dust according to IEC

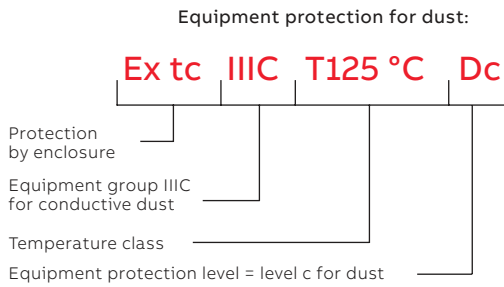
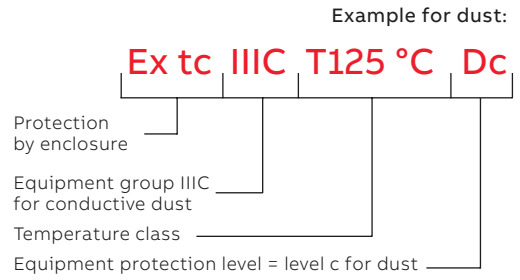

Selection of products for explosive atmospheres, EN Standard and ATEX Directive for dust environments

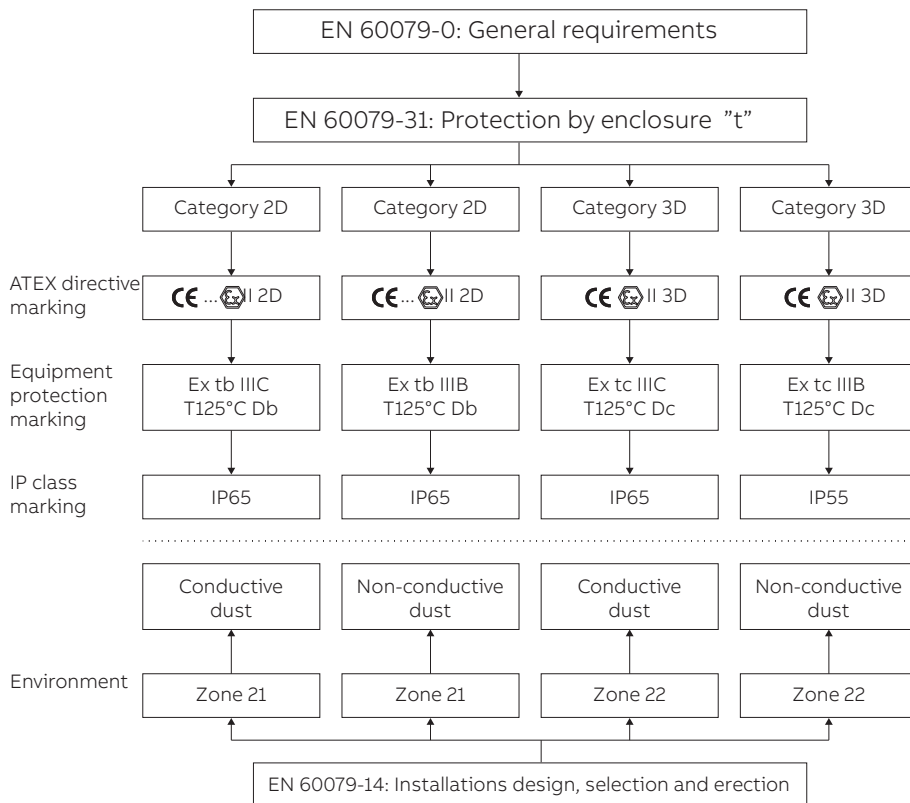

Testing and certificates

Motors for explosive atmospheres have to be officially approved by a recognized test organization, authorized to issue test certificates, to ensure compliance with standards for this type of equipment.

ABB low voltage motors for explosive atmospheres are classified according to the categories, protection types and equipment protection type which are specified in the relevant standards.

Depending on the nature of the potentially explosive atmosphere, it is the responsibility of the user to determine which group and which maximum surface temperature should be specified for the motor installation.

The motors are rated and certified for ambient temperature between -20 °C and $+40\text{ °C}$ according to standards. For ambient temperatures below -20 °C and above $+40\text{ °C}$ certificates are available for most of the motors.

ABB's motors conform to the stringent standards set by CENELEC (European Committee for Electrotechnical Standardization) and IEC (International Electrotechnical Commission), and are approved by testing laboratories (ExNB/Notified Body) and certification bodies (ExCB).

The motors can be certified according to the ATEX Directive by any of the Notified Bodies "ExNB" of EU member countries. These motors are therefore acceptable in all EU countries and many other countries. In addition, IECEX certificates are available for the most motor types. These certificates can be issued by any registered IECEX certification body (ExCB) worldwide.

Certification other than ATEX or IECEX

The certification provided as standard (ATEX and usually IECEX), is accepted in countries where these are mandatory or accepted as a substitute for other local certification, in addition are they also commonly accepted in countries which do not have any specific certification requirements.

There is number of countries which according to their local regulations require a specific certificate

for equipment installed in explosive atmospheres, examples of such certificates are:

- Inmetro certification for Brazil
- Canadian electric code CEC certification for Canada
- CNEx approval for China, can be issued by bodies like CQST, NEPSI and PCEC
- EAC certificate according to the Customs Union Technical Regulation for Russia, Kazakhstan, Belarus, Armenia and Kyrgyzstan
- PESO certification for India
- Certificates issued by TIIS for Japan
- Certificates issued by KOSHA, KGS or KTL for South Korea
- IA certificates for South Africa issued by laboratories like SABS or Explolabs
- Certificates issued by ITRI for Taiwan
- UkrSEPRO certification for Ukraine
- NEC National electric code certification of USA

ABB is maintaining a wide selection of local certificates for the different products, please refer to the variant code section for each product for information about availability. The marking of the products certified according a specific local certification system is usually differing from the ATEX and IECEX markings, this means that the ATEX and IECEX markings will be replaced with the markings required for the local certification system if a such is ordered.

International motor efficiency standards and regulations

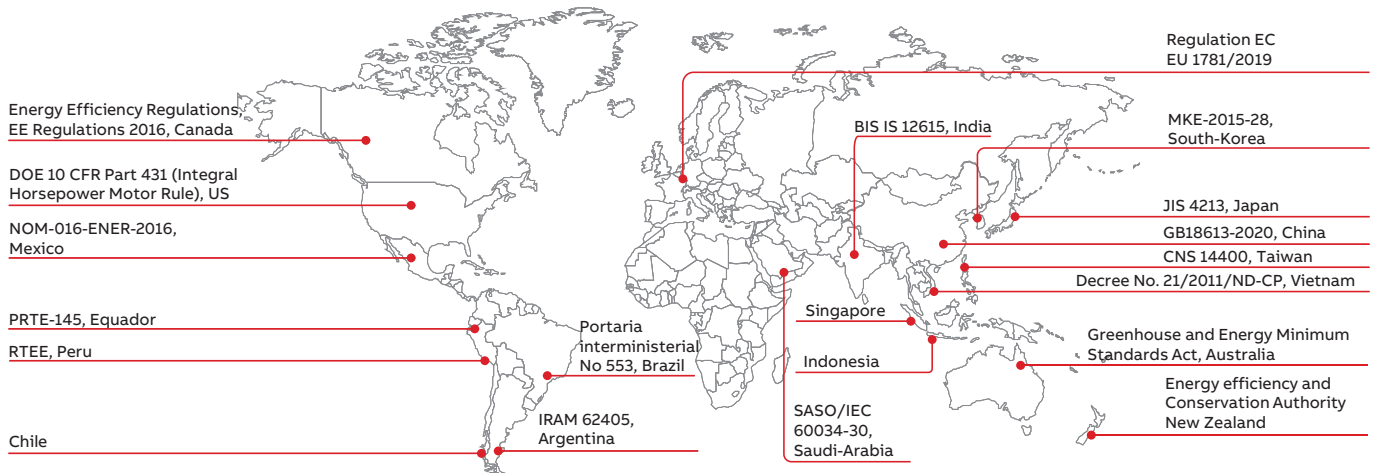

Since the validation of IEC 60034-30:2008 and its refined version IEC 60034-30-1:2014, a worldwide energy efficiency classification system has existed for low-voltage, three-phase asynchronous motors. These international standards are created to enable and increase the level of harmonization in efficiency regulations around the world, including for motors for explosive atmospheres. IEC 60034-30-1:2014 defines International Efficiency (IE) classes for single-speed, three-phase, 50 Hz and 60 Hz induction motors. The efficiency levels defined in IEC 60034-30-1 are based on the test method specified in IEC 60034-2-1:2014. Both standards are part of an effort to unify motor testing procedures with CSA390-10 and IEEE 112 standards, as well as efficiency and product labeling (IE) requirements to enable motor purchasers worldwide to easily recognize premium-efficiency products.

To promote transparency in the market, IEC 60034-30-1 states that both the efficiency class and efficiency value must be shown on the motor rating plate and in product documentation. The documentation must clearly indicate the efficiency testing method used, as the different methods can produce differing results.

International standards and regulations for motors in potentially explosive atmospheres or in hazardous locations (HazLoc) are often based on the IEC 60079 series of standards. The IECEx certification scheme is voluntary certification, but it gives a solid basis for other, regional or local certifications since a third party, both CB/TL, is involved.

Regional and local certification schemes, like ATEX, are based on the same IEC standards but, may have some additional requirement, e.g. marking. Some testing may also be required.

Minimum Energy Performance Standards (MEPS)

While the IEC, as an international standardization organization, sets guidelines for motor testing and efficiency classes, the organization does not regulate efficiency levels in countries. The biggest drivers for mandatory Minimum Energy Performance Standard (MEPS) levels for electric motors are global climate change, government targets to cut CO₂ emissions, and rising electricity demand, especially in developing countries. The whole value chain, from manufacturer to end user, must be aware of the legislation in order to meet local requirements, save energy and reduce their carbon footprint.

It is important to note that even though IEC 60034-30-1 gives efficiency levels for motors in explosive atmospheres, the local regulations will set the mandatory requirement, and e.g. in Europe, Ex motors are included in the scope of the new regulation 2019/1781 that entered into force July 2021. In Brazil the increased safety ec motors are included in the Brazilian regulator. Similarly, in some countries “explosion-proof” motors may be included or excluded from local regulations.

Harmonized global standards and the increasing adoption of MEPS around the world are good news for all of us. However, it is important to remem-

ber that harmonization is an ongoing process. Even though MEPS are already in effect in several regions and countries, they are evolving, and they differ in terms of scope and requirements. At the same time, more countries are planning to adopt their own MEPS regulations. A view of existing and coming MEPS regulations in the world can be seen on the world map above.

To get the latest information please visit, www.abb.com/motors&generators/energyefficiency.

IEC/EN 60034-30-1: 2014

This standard defines four International Efficiency (IE) classes for single-speed electric motors that are rated according to IEC 60034-1 or IEC 60079-0 (explosive atmospheres) and designed for operation on sinusoidal voltage.

- IE4 = Super premium efficiency
- IE3 = Premium efficiency, identical to the table in 10CFR431 ('NEMA Premium') in the USA and CSA C390-10:2015 for 60 Hz
- IE2 = High efficiency
- IE1 = Standard efficiency

IEC 60034-30-1 covers a power range from 0.12 kW up to 1,000 kW. Most different technical constructions of electric motors are covered, as long as they are rated for direct on-line operation. The coverage of the standard includes:

- Single speed electric motors (single and three-phase), 50 and 60 Hz
- 2, 4, 6 and 8 poles
- Rated output P_N from 0.12 kW to 1000 kW
- Rated voltage U_N above 50 V up to 1 kV
- Motors, capable of continuous operation at their rated power with a temperature rise within the specified insulation temperature class
- Motors, marked with any ambient temperature within the range of -20 °C to +60 °C
- Motors, marked with an altitude up to 4000 m above sea level

By comparing IEC 60034-30-1 to CSA C390-10:2015 and 10CFR431 Subpart B (Electric motors), it can be seen that efficiency limits and tables are well aligned, with the major difference being in the scope of the output power, where CSA and 10CFR431 have a maximum power of 500 hp. There are also some minor differences in the scope of excluded motors.

Note: CFR stands for "Code of Federal Regulations."

The following motors are excluded from IEC/EN 60034-30-1:

- Single-speed motors with 10 or more poles or multi-speed motors
- Motors completely integrated into a machine (for example, pump, fan or compressor) that cannot be tested separately from machine
- Brake motors, when the brake can not be dismantled or separately fed

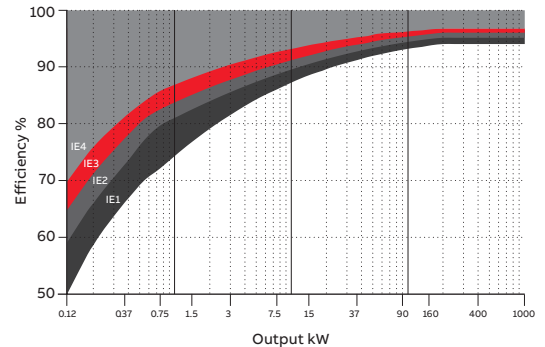

01

ABB and efficiency standards

ABB determines efficiency values according to IEC 60034-2-1 using the low uncertainty method (i.e. summation of losses), with additional load losses determined by the residual loss method.

It is good to mention and emphasize that the IEC 60034-2-1 test method, an indirect method, is technically equivalent to the test methods in the standards CSA 390-10 and IEEE 112 Method B, leading to the equivalent losses and thus efficiency values. Both test methods can be used by ABB, and will be used for both Canada and US, which do not yet recognize IEC 60034-2-1.

As the world market leader, ABB offers the largest range of LV motors available. It has long advocated the need for efficiency in motors, and high-efficiency products have formed the core of its portfolio for many years. The core of ABB's Process performance range is based on a full range of IE2 and IE3 motors - with many available from stock. We also supply IE4 motors for additional energy savings.

**Minimum efficiency values defined in IEC/
EN 60034-30-1: 2014 (reference values at 50
Hz, based on test methods specified in IEC
60034-2-1 which has been updated to edition
2.0, 2014-06).**

Output kW	IE1 Standard efficiency				IE2 High efficiency				IE3 Premium efficiency				IE4 Super Premium efficiency			
	2 pole	4 pole	6 pole	8 pole	2 pole	4 pole	6 pole	8 pole	2 pole	4 pole	6 pole	8 pole	2 pole	4 pole	6 pole	8 pole
0.12	45.0	50.0	38.3	31.0	53.6	59.1	50.6	39.8	60.8	64.8	57.7	50.7	66.5	69.8	64.9	62.3
0.18	52.8	57.0	45.5	38.0	60.4	64.7	56.6	45.9	65.9	69.9	63.9	58.7	70.8	74.7	70.1	67.2
0.20	54.6	58.5	47.6	39.7	61.9	65.9	58.2	47.4	67.2	71.1	65.4	60.6	71.9	75.8	71.4	68.4
0.25	58.2	61.5	52.1	43.4	64.8	68.5	61.6	50.6	69.7	73.5	68.6	64.1	74.3	77.9	74.1	70.8
0.37	63.9	66.0	59.7	49.7	69.5	72.7	67.6	56.1	73.8	77.3	73.5	69.3	78.1	81.1	78.0	74.3
0.40	64.9	66.8	61.1	50.9	70.4	73.5	68.8	57.2	74.6	78.0	74.4	70.1	78.9	81.7	78.7	74.9
0.55	69.0	70.0	65.8	56.1	74.1	77.1	73.1	61.7	77.8	80.8	77.2	73.0	81.5	83.9	80.9	77.0
0.75	72.1	72.1	70.0	61.2	77.4	79.6	75.9	66.2	80.7	82.5	78.9	75.0	83.5	85.7	82.7	78.4
1.1	75.0	75.0	72.9	66.5	79.6	81.4	78.1	70.8	82.7	84.1	81.0	77.7	85.2	87.2	84.5	80.8
1.5	77.2	77.2	75.2	70.2	81.3	82.8	79.8	74.1	84.2	85.3	82.5	79.7	86.5	88.2	85.9	82.6
2.2	79.7	79.7	77.7	74.2	83.2	84.3	81.8	77.6	85.9	86.7	84.3	81.9	88.0	89.5	87.4	84.5
3	81.5	81.5	79.7	77.0	84.6	85.5	83.3	80.0	87.1	87.7	85.6	83.5	89.1	90.4	88.6	85.9
4	83.1	83.1	81.4	79.2	85.8	86.6	84.6	81.9	88.1	88.6	86.8	84.8	90.0	91.1	89.5	87.1
5.5	84.7	84.7	83.1	81.4	87.0	87.7	86.0	83.8	89.2	89.6	88.0	86.2	90.9	91.9	90.5	88.3
7.5	86.0	86.0	84.7	83.1	88.1	88.7	87.2	85.3	90.1	90.4	89.1	87.3	91.7	92.6	91.3	89.3
11	87.6	87.6	86.4	85.0	89.4	89.8	88.7	86.9	91.2	91.4	90.3	88.6	92.6	93.3	92.3	90.4
15	88.7	88.7	87.7	86.2	90.3	90.6	89.7	88.0	91.9	92.1	91.2	89.6	93.3	93.9	92.9	91.2
18.5	89.3	89.3	88.6	86.9	90.9	91.2	90.4	88.6	92.4	92.6	91.7	90.1	93.7	94.2	93.4	91.7
22	89.9	89.9	89.2	87.4	91.3	91.6	90.9	89.1	92.7	93.0	92.2	90.6	94.0	94.5	93.7	92.1
30	90.7	90.7	90.2	88.3	92.0	92.3	91.7	89.8	93.3	93.6	92.9	91.3	94.5	94.9	94.2	92.7
37	91.2	91.2	90.8	88.8	92.5	92.7	92.2	90.3	93.7	93.9	93.3	91.8	94.8	95.2	94.5	93.1
45	91.7	91.7	91.4	89.2	92.9	93.1	92.7	90.7	94.0	94.2	93.7	92.2	95.0	95.4	94.8	93.4
55	92.1	92.1	91.9	89.7	93.2	93.5	93.1	91.0	94.3	94.6	94.1	92.5	95.3	95.7	95.1	93.7
75	92.7	92.7	92.6	90.3	93.8	94.0	93.7	91.6	94.7	95.0	94.6	93.1	95.6	96.0	95.4	94.2
90	93.0	93.0	92.9	90.7	94.1	94.2	94.0	91.9	95.0	95.2	94.9	93.4	95.8	96.1	95.6	94.4
110	93.3	93.3	93.3	91.1	94.3	94.5	94.3	92.3	95.2	95.4	95.1	93.7	96.0	96.3	95.8	94.7
132	93.5	93.5	93.5	91.5	94.6	94.7	94.6	92.6	95.4	95.6	95.4	94.0	96.2	96.4	96.0	94.9
160	93.8	93.8	93.8	91.9	94.8	94.9	94.8	93.0	95.6	95.8	95.6	94.3	96.3	96.6	96.2	95.1
200	94.0	94.0	94.0	92.5	95.0	95.1	95.0	93.5	95.8	96.0	95.8	94.6	96.5	96.7	96.3	95.4
250	94.0	94.0	94.0	92.5	95.0	95.1	95.0	93.5	95.8	96.0	95.8	94.6	96.5	96.7	96.5	95.4
315	94.0	94.0	94.0	92.5	95.0	95.1	95.0	93.5	95.8	96.0	95.8	94.6	96.5	96.7	96.6	95.4
355	94.0	94.0	94.0	92.5	95.0	95.1	95.0	93.5	95.8	96.0	95.8	94.6	96.5	96.7	96.6	95.4
400	94.0	94.0	94.0	92.5	95.0	95.1	95.0	93.5	95.8	96.0	95.8	94.6	96.5	96.7	96.6	95.4
450	94.0	94.0	94.0	92.5	95.0	95.1	95.0	93.5	95.8	96.0	95.8	94.6	96.5	96.7	96.6	95.4
500-1000	94.0	94.0	94.0	92.5	95.0	95.1	95.0	93.5	95.8	96.0	95.8	94.6	96.5	96.7	96.6	95.4

Mounting arrangements

Foot-mounted motor

Code I / code II

Product code pos. 12

A: foot-mounted, term. box top
R: foot-mounted, term. box RHS
L: foot-mounted, term. box LHS

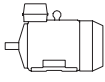
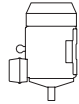
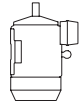
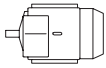
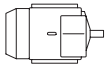
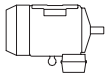
					
IM B3	IM V5	IM V6	IM B6	IM B7	IM B8
IM 1001	IM 1011	IM 1031	IM 1051	IM 1061	IM 1071

Flange-mounted motor, large flange

Code I / code II

Product code pos. 12

B: flange mounted, large flange

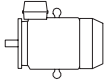
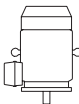
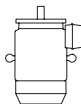
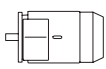
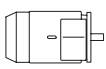
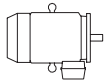
					
IM B5	IM V1	IM V3	*)	*)	*)
IM 3001	IM 3011	IM 3031	IM 3051	IM 3061	IM 3071

Flange-mounted motor, small flange

Code I / code II

Product code pos. 12

C: flange mounted, small flange

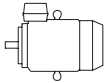
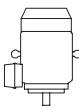
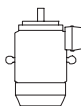
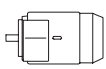
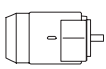
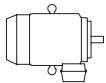
					
IM B14	IM V18	IM V19	*)	*)	*)
IM 3601	IM 3611	IM 3631	IM 3651	IM 3661	IM 3671

Foot- and flange-mounted motor with feet, large flange

Code I / code II

Product code pos. 12

H: foot/flange-mounted, term. box top
S: foot/flange-mounted, term. box RHS
T: foot/flange-mounted, term. box LHS

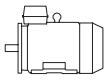
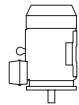
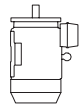
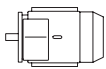
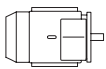
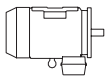

					
IM B35	IM V15	IM V35	*)	*)	*)
IM 2001	IM 2011	IM 2031	IM 2051	IM 2061	IM 2071

Foot- and flange-mounted motor with feet, small flange

Code I / code II

Product code pos. 12

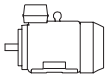

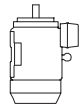
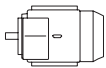
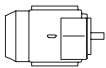
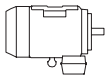
J: foot/flange-mounted, small flange

					
IM B34	IM V17				
IM 2101	IM 2111	IM 2131	IM 2151	IM 2161	IM 2171

Foot-mounted motor, shaft with free extensions

Code I / code II

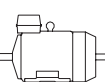
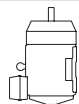
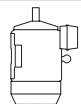
Product code pos. 12

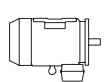
					
IM 1002	IM 1012	IM 1032	IM 1052	IM 1062	IM 1072

*) Not stated in IEC 60034-7.

Note: If the motor is mounted shaft upwards, take measures to prevent water or any other liquid from running down the shaft into the motor.

Voltage and frequency

01 Voltage and frequency deviation in zones A and B.

The table values for output, speed, efficiency, power factor, starting torque and starting current apply at the rated voltage and frequency. These values will be affected if the supply voltage or frequency deviate from the rated values.

The motors can operate continuously at the rated output, with a long-term voltage deviation of 5 % from the specified value or range of values, and the rated frequency not deviating more than 2% (zone A), without exceeding the temperature class stamped on the rating plate. The temperature rise of the winding may increase by 10 K, but without exceeding the insulation temperature class stamped on the rating plate. Voltage deviations of up to 10 % are permissible for short periods only.

If the motor is subject to continuous voltage variations of +/- 10 % this should be taken into consideration in the design. The permitted combinations of voltage and frequency tolerances are specified in IEC60034-1. This is illustrated in the figure below.

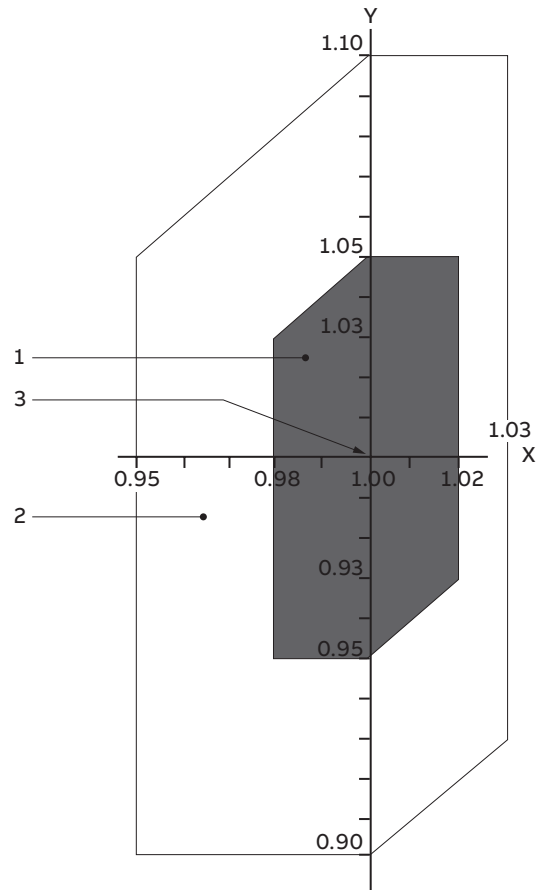

01

Key	
X axis	frequency p.u.
Y axis	voltage p.u.
1	zone A
2	zone B (outside zone A)
3	rating point

Cooling

Designation system concerning methods of cooling refers to standard IEC 60034-6. Standard cooling method is IC411. For further information please see the variant code section of each motor type for availability of other cooling methods.

Explanation of the product code

International Cooling	Circuit arrangement	Primary coolant	Method of movement of primary coolant	Secondary coolant	Method of movement of secondary coolant
IC	4	(A)	1	(A)	6
	1	2	3	4	5

Position 1

0:	Free circulation (open circuit)
4:	Frame surface cooled

Position 2

A:	For air (omitted for simplified designation)
----	--

Position 3

0:	Free convection
1:	Self-circulation
6:	Machine-mounted independent component

Position 4

A:	For air (omitted for simplified designation)
W:	For water

Position 5

0:	Free convection
1:	Self-circulation
6:	Machine-mounted independent component
8:	Relative displacement

Degrees of protection: IP code and resistance to impact

Classification for degrees of protection (IP code) provided by enclosures of rotating machines are defined in standards IEC 60034-5 or EN 60529.

means an impact energy strength of 7J for both enclosure and fan cover.

IP protection

Protection of persons against getting in contact with (or approaching) live parts and against contact with moving parts inside the enclosure. Also protection of the machine against ingress of solid foreign objects. Protection of machines against the harmful effects due to the ingress of water.

Explanation of the IP code

Ingress protection	Degree of protection to persons and to parts of the motors inside the enclosure	Degree of protection provided by the enclosure with respect to harmful effects due to ingress of water
IP	5	5
	1	2

Position 1

2:	Motors protected against solid objects greater than 12 mm
4:	Motors protected against solid objects greater than 1 mm
5:	Dust-protected motors
6:	Dust-tight motors

Position 2

3:	Motors protected against spraying water
4:	Motors protected against splashing water
5:	Motors protected against water jets
6:	Motors protected against heavy seas

Following IEC/EN 60079-0 non-metallic parts of enclosures in motors for explosive atmospheres must be thermal endurance tested for the temperature range the motors are designed for. Non-metallic parts are, for instance, rubber seals and gaskets. Thermal endurance tests and impact tests are carried out before the ingress protection test. This ensures that the motors meet the ingress protection level also after been put in service.

Resistance to impact

ABB's motors for explosive atmospheres have been tested for resistance to impact as described in IEC/EN 60079-0. The more demanding high risk of mechanical danger limits have been used as qualification criteria. For group II and III motors this

Insulation

01 Safety margins per thermal class.

ABB uses class F insulation, which, with temperature rise B, is the most common requirement among industry today.

The use of class F insulation with class B temperature rise gives ABB products a 25 °C safety margin. This can be used to increase the loading for limited periods, to operate at higher ambient temperatures or altitudes, or with greater voltage and frequency tolerances. It can also be used to extend insulation. For instance, a 10 K temperature reduction will extend the insulation life.

Thermal class 130 (B)

- Nominal ambient temperature 40 °C
- Max permissible temperature rise 80 K
- Hot spot temperature margin 10 K

Thermal class 155 (F)

- Nominal ambient temperature 40 °C
- Max permissible temperature rise 105 K
- Hot spot temperature margin 10 K

Thermal class 180 (H)

- Nominal ambient temperature 40 °C
- Max permissible temperature rise 125 K
- Hot spot temperature margin 10 K

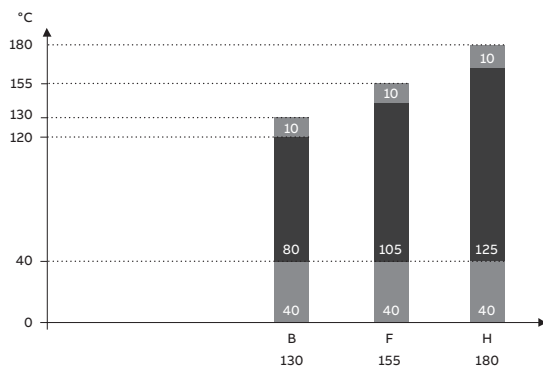

01

Surface treatment

The standard surface treatment of the Process performance motors is designed to meet corrosivity category C3, both outdoors and indoors. This also meets the requirements in C1 and C2.

The corrosivity categories are defined in standard ISO12944-2.

Special surface treatments for other corrosivity categories as well as offshore environments are available as options.

The standard ABB paint color for motors is Munsell blue 8B 4.5/3.25, except for special systems such as NORSOK where a specific color is requested.

Atmospheric-corrosivity categories and examples of typical environments

Corrosivity category	Examples of typical environments (informative only)	
	Exterior	Interior
C1	-	Heated buildings with clean atmospheres, e.g., offices, shops, schools, hotels
C2	Atmospheres with low levels of pollution: mostly rural areas	Unheated buildings where condensation can occur, e.g., depots, sports halls
C3	Urban and industrial atmospheres, moderate sulfur dioxide pollution; coastal areas with low salinity	Production rooms with high humidity and some air pollution, e.g., food-processing plants, laundries, breweries, dairies
C4	Industrial areas and coastal areas with moderate salinity	Chemical plants, swimming pools, coastal ship- and boatyards
C5	Industrial areas with high humidity and an aggressive atmosphere, and coastal areas with high salinity	Buildings or areas with almost permanent condensation and with high pollution
CX	Offshore areas with high salinity, and industrial areas with extreme humidity and an aggressive atmosphere, and sub-tropical and tropical atmospheres	Industrial areas with extreme humidity and an aggressive atmosphere

Low voltage motors and frequency converters for explosive atmospheres

Frequency converters provide significant benefits when used with motors for explosive atmospheres. The advantages include better process control through regulation of the motor speed, as well as energy savings, and therefore improved environmental performance.

Certain criteria must be taken into account to ensure the safety of the frequency converter and motor combination, as well as the maximum usability of the application. The requirements depend on the protection type in use and whether the motor is regarded as being one component within a wider system or a separate subsystem.

ABB offers motors for explosive atmospheres for use with variable speed drives with the following protection types: flameproof, increased safety (on request), non-sparking, and dust ignition proof. These motors are designed and certified for operation with frequency converters. Solutions for the different protection types, as well as for the most common types of converter, are provided below. Further information is provided in the installation, operation and maintenance and safety manual. The flame proof, non-sparking or increased safety Ex ec and dust ignition proof motors covered by this catalogue have been tested with ABB ACS800, ACS880 converters with DTC control, and ACS 550 and ACS580 converters with scalar control or vector control.

1. Thermal dimensioning and protection

The IEC and EN standards sets the requirements for ensuring surface temperature class is not exceeded, the allowed methods does vary slightly between different protection types, generally are the following methods accepted: Combined type test for the duty with the converter, or direct surface temperature protection with embedded temperature sensors such as PTC or Pt100. Tripping temperature of detectors must be selected and certified to protect the surface temperature class of the motor.

	Flameproof Ex d / Ex de or Ex db / Ex db eb T4	Increased safety Ex ec, T3	Dust ignition proof – Ex t T125°C or T150°C
Criteria for safe operation	Outer surface temperature may not exceed the temperature class	Surface temperature of any part inside or outside the motor may not exceed temperature class in normal operation	Outer surface temperature may not exceed temperature class (eg. 125°C)
Use with ABB ACS 800, ACS 880 with DTC control, or ACS 550, ACS580 converters	Combination have already been type tested, no need for further testing when specific loadability curves are followed Optional direct surface temperature protection with temperature detectors (VC813 or 816)	Combination have already been type tested, no need for further testing when specific loadability curves are followed	Combination have already been type tested, no need for further testing when specific loadability curves are followed Optional direct surface temperature protection with temperature detectors (VC813 or 816), temperature class = T150°C
Use with other type of PWM & vc 813	Mandatory direct temperature protection with temperature detectors (VC813 or 816)	Must be tested with the specific converter	Surface temperature protection with temperature detectors (VC813, 816), temperature class T150°C
Operation with frequency converter is included in standard certificates	Yes, in addition is an addendum to the ATEX declaration of conformity available for the combination	Yes, in addition is an addendum to the ATEX declaration of conformity available for the combination	Yes, in addition is an addendum to the ATEX declaration of conformity available for the combination

Use of motors with a temperature class requiring a lower surface temperature than indicated in table, must be dimensioned case by case, a combined type test of converter and motor is usually required to verify safe operation.

Optionally can the thermistors mounting in the stator winding be dimensioned and certified to also protect the surface temperature of flame proof motors with temperature class T4 and dust ignition proof motors with temperature class T150°C. This is done by adding variant code 813. For motors which have been tested together with the converter is the use of such temperature detectors optional when the designated loadability curves in section 7 are followed, but still recommended as they provide useful additional protection. For non-tested combinations, like when used with converters of other brands than ABB, are they mandatory to use unless a separate combined test is arranged. Variant code 816 should be used if surface temperature protection using Pt100 is preferred.

Surface temperature protection with temperature detectors cannot be reliably arranged in increased safety and non-sparking motors as these protection types includes protection of all surface temperatures, external and internal. In such motors will the temperature detectors only protect the insulation.

In countries where the ATEX directive is in force must thermistors or other temperature detectors, if connected, be connected to an ATEX approved relay that does function independently and does reliably trip off the supply to the motor. Such approved temperature detector relays are available as a standard integrated option to many frequency converters from ABB, but can also be separate controlling the supply to the converter.

01 Permitted phase to phase voltage peaks at motor terminals as a function of rise time.

2. Operating speed

When a motor is used with a frequency converter, its actual operating speed may deviate considerably from its nominal speed (i.e. the speed stamped on the rating plate). When operating at higher speeds, ensure that the highest permissible rotational speed of the motor, or the critical speed of the equipment as a whole, is not exceeded.

The permitted maximum speed must be stated on a rating plate. This can be either a separate plate or the regular plate required for variable speed drive motors.

3. Rating plates

The EN and IEC standards require that the motors which are used in variable speed operation are provided with a rating plate that show the parameters for which the motor is intended. There are two different types of rating plates available, one generic plate that show loadability values in percent of the nominal torque. This plate can be ordered using variant code 181. The other plate is have order specific data, this can be ordered using variant code 163.

ABB CONVERTER SUPPLY	
Valid for	380-415 V FWP 50 Hz
3- Motor	M3KP 280SMB 4 IMB3/IM1001
No.	3G1F2140770443
Min. switching frequency:	DTC: 2 kHz PWM: 3 kHz
$I = 1,5 \times I_N$	$t_{OL} = 10 \text{ s}$ $t_{COOL} = 10 \text{ min}$
Ex. Temp. Control for converter operation by PTC	
Duty S9	ACS800/880 with DTC CONTROL
f [Hz]	5 20 45 50 60
T/Tn [%]	75 90 100 92 76
ACS550/580/Other PWM	
f [Hz]	15 20 45 50 60
T/Tn [%]	80 85 95 87 71
PTC 155°C DIN 44081/-82	
IEC60034-1	

ABB CONVERTER SUPPLY						
3- Motor	M3KP 280SMB 4 IMV1/IM3011					
No.	3G1F2121757200					
Frequency converter type	ACS800/880/DTC					
Switching frequency	2 kHz FWP 400VD 50Hz					
Ex. Temp. Control for converter operation by PTC						
V	Hz	kW	r/min	A	Nm	Duty
82 D	10.2	11.3	294	107	366	S9
400 D	54.4	62.3	1617	116	366	S9
CONSTANT TORQUE 294 - 1617 RPM						
PTC 155°C DIN 44081/-82						

These parameters shall be used while checking the suitability of a specific motor for its intended application and for setting the limits of operation for the converter.

4. Winding insulation

The output voltage of voltage source frequency converters consists of steep voltage pulses. These pulses can be even higher and steeper when arriving at the motor terminals due to reflecting pulses in the cables. The motor's insulation must therefore be selected according to the actual pulses at the motor terminals.

4.1 Phase to phase voltages

The maximum permitted phase to phase voltage peaks at the motor terminals as a function of pulse rise time can be seen in Figure 1.

The highest curve ("ABB Special Insulation") applies to random wound motors with a special winding insulation for frequency converter supply, variant code 405. The "ABB Standard Insulation" curve applies to all other random wound motors covered by this catalog.

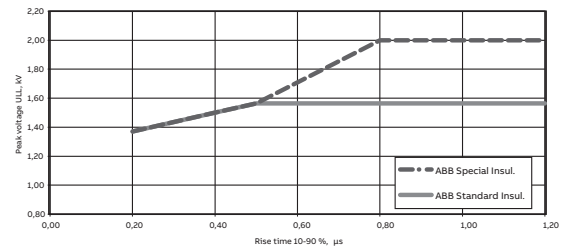

01

4.2 Phase to ground voltages

The permitted phase to ground voltage peaks at the motor terminals are:

- Standard Insulation 1300 V peak
- Special Insulation 1800 V peak

4.3 Selection of winding insulation for motors used with ABB converters

In the case of ABB ACS800, ACS 880, ACS550 and ACS580 single drives with a diode supply unit (uncontrolled DC voltage), the motor winding insulation and frequency converter output filters can be selected using Table 2.

Nominal supply voltage U_N of converter	Winding insulation and filters required
Nominal supply voltage U_N of converter $U_N \leq 500 \text{ V}$	Standard insulation
Nominal supply voltage U_N of converter $U_N \leq 600 \text{ V}$	ABB Standard insulation + dU/dt filters OR ABB Special insulation (variant code 405)
Nominal supply voltage U_N of converter $U_N \leq 690 \text{ V}$	ABB Special insulation (variant code 405) AND dU/dt-filters at converter output

Nominal supply voltage U_N of converter	Winding insulation and filters required
Nominal supply voltage U_N of converter $600\text{ V} < U_N \leq 690\text{ V}$ cable length > 150 m	ABB Special insulation (variant code 405)

Table 2. Selection of motor winding insulation and converter output filters for motors supplied by ABB ACS800, ACS880, ACS550 or ACS 580 drives with uncontrolled DC voltage.

4.4 Selection of winding insulation with all other converters

The voltage stresses must be restricted so they remain below the accepted limits given in paragraphs 4.1 and 4.2. The effect of any filters that are fitted must be taken into account when dimensioning the motor.

5. Bearing currents

Bearing voltages and currents must be avoided in all variable speed applications to ensure the reliability and safety of the application. For this purpose insulated bearings or bearing constructions, common mode filters and suitable cabling and grounding methods must be used.

5.1 Elimination of bearing currents with ABB ACS800, ACS880 and ACS550 converters

In the case of ABB ACS800, ACS880, ACS550 and ACS580 converters with a diode supply unit (uncontrolled DC voltage), the following methods must be used to avoid harmful bearing currents in the motors:

Frame size	Preventive measures
250 and smaller	No action needed
280-315	Insulated non-drive end bearing
355-450	Insulated non-drive end bearing AND Common mode filter at the converter

Common mode filters

Common mode filters reduce common mode currents and thus decrease the risk of bearing currents. Common mode filters do not significantly affect the phase or main voltages on the motor terminals. For more information, please see ABB Drives catalogues.

Insulated bearings

Bearings with aluminum oxide insulated and sealed inner or outer bores are used as standard with variant code 701. Hybrid bearings, i.e. bearings with non-conductive ceramic rolling elements, can also be used in special applications. More information on selection of the correct parts is available on request.

5.2 Elimination of bearing currents with all other converters

The user is responsible for protecting the motor and driven equipment from harmful bearing currents. The instructions provided in section 5.1 can be followed, but their effectiveness cannot be guaranteed in all cases.

6. Cabling, grounding and EMC

The use of a frequency converter places greater demands on the cabling and grounding of the drive system. To ensure proper grounding of the system, EMC compliance and avoiding bearing currents should the instructions given in the installation, operation, maintenance manual be followed. EMC cable glands providing 360° bonding of a concentric PE conductor are available using variant code 704, also many flameproof glands for armoured cable provide similar bonding.

7. Loadability curves

The loadability curves presented below are based on combined tests of different motors together with the converter types listed. The loadability curves assume that the nominal frequency of the motor (i.e. field weakening point) is 50 or 60Hz. The curves presents the maximum allowed torque in percentage of the nominal direct on line torque of the motor over the speed range.

7.1 Loadability curves with ACS800/880 converters utilizing DTC control

50 Hz fwp

Flameproof motors Ex d/ Ex db / Ex de / Ex db eb T4, frame sizes 80-400
Dust ignition protection cast iron motors Ex t T150 °C, frame sizes 71-400

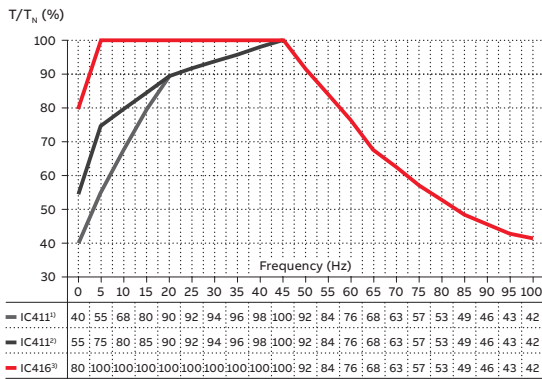

- ¹⁾ Self ventilated, IEC frame size 71 - 132
- ²⁾ Self ventilated, IEC frame size 160 - 400
- ³⁾ Separate motor cooling (force ventilated), IEC frame size 160 - 400

60 Hz fwp

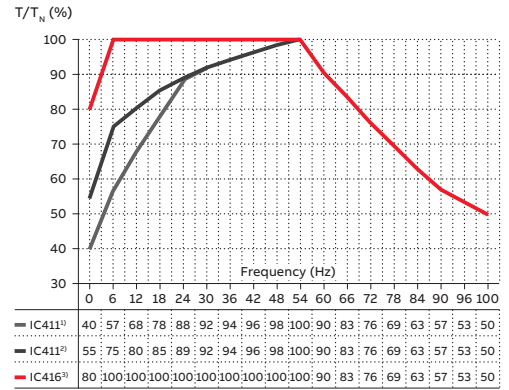

- ¹⁾ Self ventilated, IEC frame size 71 - 132
- ²⁾ Self ventilated, IEC frame size 160 - 400
- ³⁾ Separate motor cooling (force ventilated), IEC frame size 160 - 400

Increased safety motors Ex ec, cast iron and aluminum
Dust ignition protection motors Ex t T125 °C

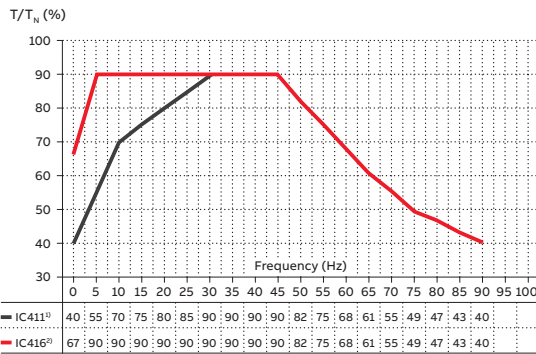

- ¹⁾ Self ventilated, IEC frame size 71 - 450
- ²⁾ Separate motor cooling (force ventilated)

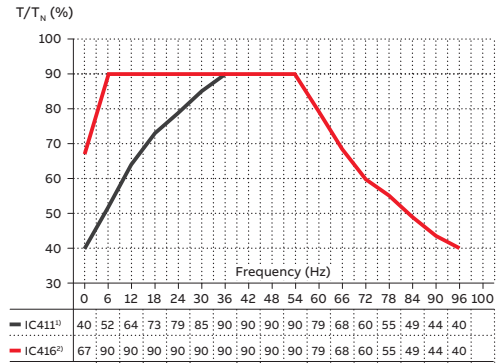

- ¹⁾ Self ventilated, IEC frame size 71 - 450
- ²⁾ Separate motor cooling (force ventilated)

Flameproof motors Ex d/ Ex db / Ex de / Ex db eb T4, frame size 450
Dust ignition protection cast iron motors Ex t T150°C, frame size 450

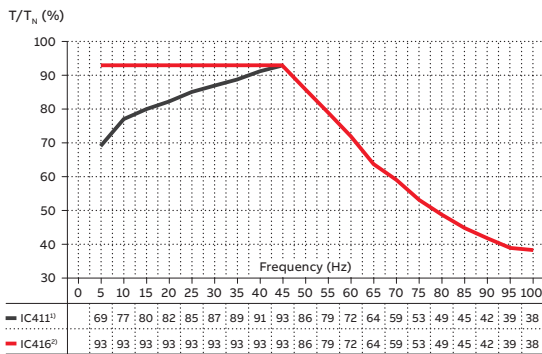

- ¹⁾ Self ventilated, IEC frame size 450
- ²⁾ Separate motor cooling (force ventilated)

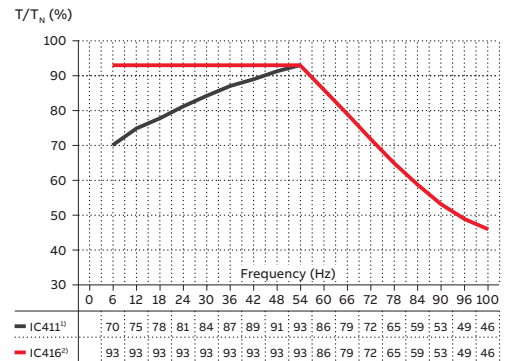

- ¹⁾ Self ventilated, IEC frame size 450
- ²⁾ Separate motor cooling (force ventilated)

7.2 Loadability curves with ACS580 converter- with vector or scalar control

50 Hz fwp

Flameproof motors Ex d, Ex db Ex de, Ex db eb T4

Dust ignition protection cast iron motors Ex t T150 °C

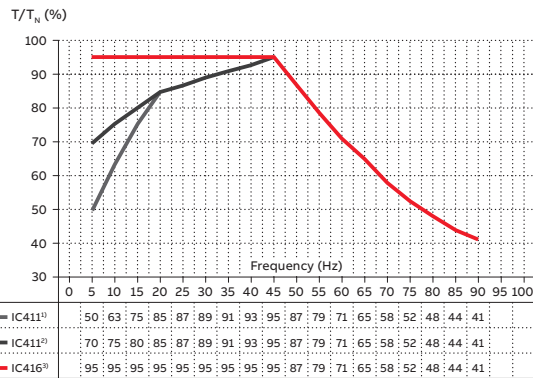

¹⁾ Self ventilated, IEC frame size 71 - 132

²⁾ Self ventilated, IEC frame size 160 - 400

³⁾ Separate motor cooling (force ventilated), IEC frame size 160 - 400

Note: The lower speed limit for constant torque loads is 15 Hz or 18 Hz

60 Hz fwp

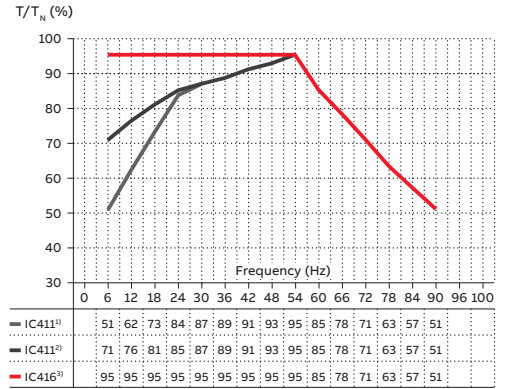

¹⁾ Self ventilated, IEC frame size 71 - 132

²⁾ Self ventilated, IEC frame size 160 - 400

³⁾ Separate motor cooling (force ventilated), IEC frame size 160 - 400

Increased safety Ex ec motors frame sizes 71-450

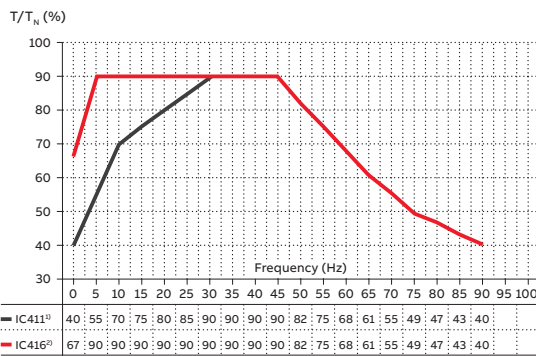

¹⁾ Self ventilated, IEC frame size 71 - 450

²⁾ Separate motor cooling (force ventilated)

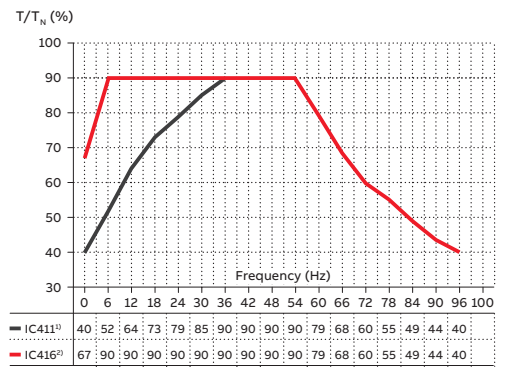

¹⁾ Self ventilated, IEC frame size 71 - 450

²⁾ Separate motor cooling (force ventilated)

7.3 Loadability with other PWM converters utilizing scalar or vector control

50 Hz fwp

Flameproof motors Ex db/ Ex db eb T4 frame sizes 80-400

Dust ignition protection motors Ext T150°C frame sizes 71-400

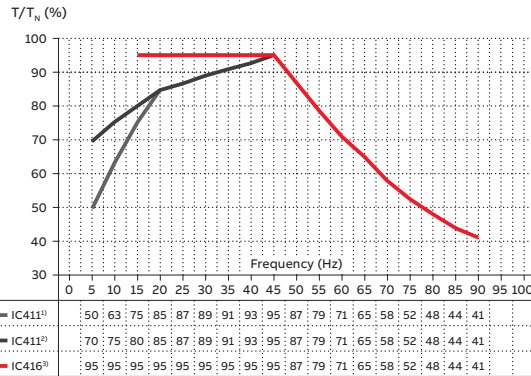

- ¹⁾ Self ventilated, IEC frame size 71 - 132
- ²⁾ Self ventilated, IEC frame size 160 - 400
- ³⁾ Separate motor cooling (force ventilated), IEC frame size 160 - 400

Note: Direct temperature protection with PTC or Pt100 is required (see section 1.1), the lower speed limit for constant torque load is 15Hz for 50Hz fwp and 18Hz for 60Hz fwp.

60 Hz fwp

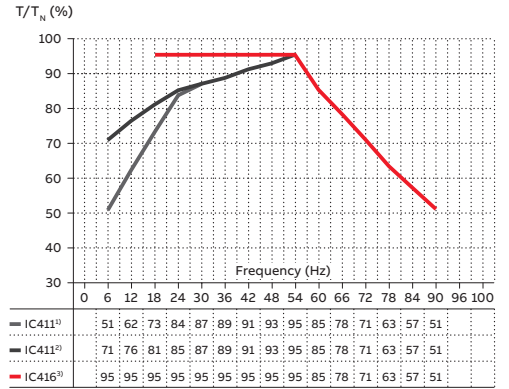

- ¹⁾ Self ventilated, IEC frame size 71 - 132
- ²⁾ Self ventilated, IEC frame size 160 - 400
- ³⁾ Separate motor cooling (force ventilated), IEC frame size 160 - 400

Dust ignition protection cast iron motors

28	Ordering information
29	Rating plates
30	Technical data IE3
30	3000 r/min motors
32	1500 r/min motors
34	1000 r/min motors
36	750 r/min motors
37	Technical data IE2
37	3000 r/min motors
39	1500 r/min motors
41	1000 r/min motors
43	750 r/min motors
45	Variant codes
50	Mechanical design
50	Motor frame and drain holes
51	Heating elements
52	Bearings
62	Terminal box
71	Dimension drawings
74	Motors in brief
74	Motor sizes 71 - 180
75	Motor sizes 200 - 400
76	Motor construction

Ordering information

Explanation of the product code

Motor type	Motor size	Product code	Mounting arrangement code, Voltage and frequency code, Generation code	Variant codes
M3GP	160MLA	3GGP 161	410 - ADD	002, etc.
		1 2 3 4 5 6 7 8 9 10 11 12 13 14		

Positions 1 to 4

3GGP: Totally enclosed fan cooled squirrel cage motor with cast iron frame, dust ignition proof

3GAA: Totally enclosed fan cooled squirrel cage motor with aluminum frame, dust ignition proof

Positions 5 and 6

IEC size

63	63
71	71
08:	80
09:	90
10:	100
11:	112
13:	132
16:	160
18:	180
20:	200
22:	225
25:	250
28:	280
31:	315
35:	355
40:	400

Position 7

Speed (Pole pairs)

1:	2 poles
2:	4 poles
3:	6 poles
4:	8 poles
5:	10 poles

Positions 8 to 10

Serial number

Position 11

- (Dash)

Position 12

Mounting arrangement

A:	Foot-mounted, top-mounted terminal box
R:	Foot-mounted, terminal box RHS seen from D-end
L:	Foot-mounted, terminal box LHS seen from D-end
B:	Flange-mounted, large flange
C:	Flange-mounted, small flange (sizes 71 to 112)
H:	Foot- and flange-mounted, terminal box top-mounted
J:	Foot- and flange-mounted, small flange with tapped holes
S:	Foot- and flange-mounted, terminal box RHS seen from D-end
T:	Foot- and flange-mounted, terminal box LHS seen from D-end
V:	Flange-mounted, special flange
F:	Foot- and flange-mounted. Special flange

Position 13

Voltage and frequency code

Single-speed motors

B:	380 VΔ 50 Hz
D:	400 VΔ, 415 VΔ, 690 VY 50 Hz
E:	500 VΔ 50 Hz
F:	500 VY 50 Hz
S:	230 VΔ, 400 VY, 415 VY 50 Hz
T:	660 VΔ 50 Hz
U:	690 VΔ 50 Hz
X:	Other rated voltage, connection or frequency, 690 V maximum

Position 14

Generation code

G, H... The product code must be, if needed, followed by variant codes.

Explanation of technical data pages:

The two bullets in the product code indicate choice of mounting arrangements, voltage and frequency code (see ordering information page).

Efficiency values are given according to IEC 60034-2-1; 2007. Please note that the values are not comparable without knowing the testing method. ABB has calculated the efficiency values according to indirect method, stray load losses (additional losses) determined from measuring.





I_s / I_N = Starting current
 T_l / T_N = Locked rotor torque
 T_b / T_N = Pull-out torque

Rating plates

The rating plates are in table form giving values for speed, current and power factor for three voltages for cast iron motors: 400V-415V-690V as standard. Other voltage and frequency combinations are possible and can be ordered with variant codes 002 or 209. Please see Variant code section.

The following information will be shown on the motor rating plate:

- Lowest nominal efficiency at 100 %, 75 % and 50 % rated load
- Efficiency level
- Year of manufacture
- Type of protection
- Apparatus group
- Temperature class
- Identification number of the certification body
- Certificate number: for cast iron motors both ATEX and IECEx are stamped on the rating plate as standard.

		ABB Oy, Motors and Generators Strömbergin puistotie 5 A 65320 Vaasa, Finland		 0081		IEC60034-1		 II 2D	
3- Motor		M3GP 160MLB 2 IMB5/IM3001				2019			
Ex tb III B T125°C Db									
164.8119-2									
No. 3G1F1919589420		Ins. cl. F		IP 65					
V	Hz	kW	r/min	A	cos φ	Duty			
690 Y	50	15	2951	15	0.90	S1			
400 D	50	15	2951	25.7	0.90	S1			
415 D	50	15	2956	25.1	0.90	S1			
IE3-93.1%(100%)-93.5%(75%)-93.0%(50%)									
Product code		3GGP161420-BDK334544							
DEMKO 18 ATEX 2077X / IECEx UL 18.0081X									
Manual: 3GZF500730-4.7									
6309/C3				6209/C3		170 kg			

Technical data for Ex t IIIB/IIIC IE3 cast iron motors, 3000 r/min

IP 55 - IC 411 - Insulation class F, temperature rise class B
IE3 efficiency class according to IEC 60034-30-1; 2014

Output kW	Motor type	Product code	Speed r/min	Efficiency IEC 60034-30-1; 2014			Power factor Cosφ	Current		Torque		Moment of inertia J = 1/4 GD ² kgm ²	Weight kg	Sound pressure Level L _{PA} dB	
				Full load 100%	3/4 load 75%	1/2 load 50%		I _N A	I _s /I _N	T _N Nm	T _i /T _N				T _b /T _N
3000 r/min = 2 poles				400 V 50 Hz				CENELEC							
0.37	M3GP 71MC 2	3GGP071330-...L	2743	73.8	74.4	71.7	0.76	0.94	4.9	1.26	2.3	2.8	0.00088	10	58
0.55	M3GP 71ME 2	3GGP071350-...L	2755	77.8	79.3	78.4	0.83	1.25	6.8	1.90	2.8	3.1	0.00045	11	56
0.75	M3GP 80MD 2	3GGP081340-...K	2872	80.7	81.1	79.4	0.87	1.51	6.2	2.43	2.9	3.4	0.0012	18	57
1.1	M3GP 80MG 2	3GGP081370-...K	2862	84.2	85.1	84.3	0.87	2.1	6.3	3.7	3.0	3.5	0.0014	19	60
1.5	M3GP 90LB 2	3GGP091520-...K	2892	86.4	87.4	86.7	0.89	2.7	7.3	4.8	2.0	3.2	0.0031	31	69
2.2	M3GP 90LC 2	3GGP091530-...K	2900	87.6	88.3	87.4	0.89	4.0	9.1	7.3	3.4	4.1	0.0044	35	64
3	M3GP 100LKA 2	3GGP101810-...K	2907	89.0	89.4	88.5	0.89	5.4	8.8	9.9	3.3	4.3	0.0086	50	68
4	M3GP 112MG 2	3GGP111370-...K	2882	88.4	89.9	90.5	0.93	7.0	8.1	13.3	2.8	4.1	0.0132	56	70
5.5	M3GP 132SMF 2	3GGP131260-...K	2902	90.7	91.3	91.0	0.90	9.7	7.3	18.2	2.7	4.2	0.0218	77	67
7.5	M3GP 132SMG 2	3GGP131270-...K	2907	91.3	92.1	92.1	0.90	13.2	8.1	24.7	3.2	4.7	0.0218	77	70
11	M3GP 160MLA 2	3GGP161410-...K	2943	92.1	92.8	92.5	0.92	18.7	8.1	35.6	2.7	3.4	0.052	141	69
15	M3GP 160MLB 2	3GGP161420-...K	2943	92.5	93.4	93.2	0.92	25.4	8.4	48.6	3.1	3.4	0.062	170	69
18.5	M3GP 160MLC 2	3GGP161430-...K	2942	93.1	93.9	93.9	0.93	30.8	8.3	60.0	3.1	3.6	0.072	183	69
22	M3GP 180MLA 2	3GGP181410-...K	2957	93.2	93.9	93.8	0.91	37.4	8.1	71.0	2.6	3.2	0.116	234	69
30	M3GP 200MLA 2	3GGP201410-...K	2958	94.2	94.8	94.6	0.90	51.0	7.8	96.8	2.8	3.1	0.196	298	72
37	M3GP 200MLB 2	3GGP201420-...K	2960	94.7	95.2	95.1	0.86	65.5	8.8	119	3.1	3.4	0.217	314	72
45	M3GP 225SMA 2	3GGP221210-...K	2972	94.9	95.1	94.7	0.89	76.8	7.8	144	3.1	3.0	0.323	409	74
55	M3GP 250SMA 2	3GGP251210-...K	2975	95.2	95.4	95.0	0.89	93.6	8.0	176	2.8	3.3	0.579	452	75
75	M3GP 280SMB 2	3GGP281220-...K	2980	95.5	95.5	94.9	0.87	129	7.3	240	2.5	2.9	0.9	665	77
90	M3GP 280SMC 2	3GGP281230-...K	2981	95.7	95.6	95.0	0.88	153	8.0	288	3.0	3.1	1.15	725	77
110	M3GP 315SMB 2	3GGP311220-...K	2982	95.9	95.9	95.2	0.88	189	6.7	352	1.9	2.6	1.4	940	77
132	M3GP 315SMC 2	3GGP311230-...K	2986	96.1	96.2	95.9	0.88	226	7.9	422	2.4	3.0	1.7	1025	77
160	M3GP 315MLA 2	3GGP311410-...K	2983	96.2	96.5	96.2	0.90	268	7.3	512	2.2	2.7	2.1	1190	77
200	¹⁾ M3GP 355SMA 2	3GGP351210-...K	2985	96.4	96.1	95.3	0.89	336	7.6	640	2.0	3.1	3	1600	83
250	M3GP 355SMB 2	3GGP351220-...K	2983	96.4	96.5	96.1	0.90	415	7.6	800	2.2	3.0	3.4	1680	83
315	¹⁾ M3GP 355SMC 2	3GGP351230-...K	2984	96.4	96.4	95.9	0.89	533	7.8	1008	2.3	2.8	3.6	1750	83
355	M3GP 355MLA 2	3GGP351410-...K	2981	96.4	96.7	96.3	0.90	595	7.5	1137	2.3	2.6	4.1	2000	83
400	¹⁾ M3GP 355MLB 2	3GGP351420-...K	2982	95.8	95.6	94.7	0.88	677	7.1	1280	2.3	2.9	4.1	2000	83
450	M3GP 355MLC 2	3GGP351430-...K	2983	95.8	95.8	95.0	0.90	743	7.9	1440	2.2	2.9	4.3	2080	83
500	¹⁾ M3GP 355LKA 2	3GGP351810-...K	2982	95.8	95.8	95.3	0.90	827	7.5	1601	2.0	3.9	4.8	2320	83
560	²⁾ M3GP 400LA 2	3GGP401510-...K	2988	95.8	95.8	94.9	0.89	934	7.8	1789	2.5	3.7	7.9	2950	82
560	M3GP 400LKA 2	3GGP401810-...K	2988	95.8	95.8	94.9	0.89	934	7.8	1789	2.5	3.7	7.9	2950	82
560	M3GP 355LKB 2	3GGP351820-...K	2983	95.8	95.8	95.1	0.90	925	8.0	1792	2.2	4.1	5.2	2460	83
630	M3GP 400LB 2	3GGP401520-...K	2987	95.8	95.5	94.8	0.89	1049	7.6	2014	2.6	3.7	8.2	3050	82
630	²⁾ M3GP 400LKB 2	3GGP401820-...K	2987	95.8	95.5	94.8	0.89	1049	7.6	2014	2.6	3.7	8.2	3050	82
710	²⁾ M3GP 400LC 2	3GGP401530-...K	2987	95.8	95.7	94.9	0.89	1178	7.2	2270	2.6	3.4	9.3	3300	82
710	M3GP 400LKC 2	3GGP401830-...K	2987	95.8	95.7	94.9	0.89	1178	7.2	2270	2.6	3.4	9.3	3300	82
800	²⁾ M3GP 450LA 2	3GGP451510-...K	2990	95.8	95.5	94.5	0.87	1362	7.8	2555	1.3	3.4	12.2	4000	85
900	²⁾ M3GP 450LB 2	3GGP451520-...K	2990	95.8	95.5	94.7	0.87	1534	7.6	2874	1.5	3.1	13.5	4200	85

¹⁾ -3dB(A) sound pressure level reduction with unidirectional fan construction. Direction of rotation must be stated when ordering, see variant codes 044 and 045.

²⁾ Unidirectional fan construction as standard. Direction of rotation must be stated when ordering, see variant codes 044 and 045.

Equipment protection level and equipment group subdivision must be selected when ordering by selecting appropriate variant code:

334 - Ex t, dust group IIIB T125 Db (non-conductive dust) acc. to IEC/EN60079-31

335 - Ex t, dust group IIIB T125 Dc (non-conductive dust) acc. to IEC/EN60079-31

336 - Ex t, dust group IIIC T125 Db (conductive dust) acc. to IEC/EN60079-31

337 - Ex t, dust group IIIC T125 Dc (conductive dust) acc. to IEC/EN60079-31

Technical data for Ex t IIIB/IIIC

IE3 cast iron motors, 3000 r/min

IP 55 - IC 411 - Insulation class F, temperature rise class B
IE3 efficiency class according to IEC 60034-30-1; 2014

Output kW	Motor type	Product code	Speed r/min	Efficiency IEC 60034-30-1; 2014			Power factor Cosφ	Current			Torque		Moment of inertia J = 1/4 GD ² kgm ²	Weight kg	Sound pressure Level L _{PA} dB
				Full load 100%	3/4 load 75%	1/2 load 50%		I _N A	I _s /I _N	T _N Nm	T _i /T _N	T _b /T _N			
3000 r/min = 2 poles				400 V 50 Hz				High-output							
200	M3GP 315MLB 2	3GGP311420-...K	2983	96.4	96.7	96.6	0.90	333	6.8	640	1.9	2.6	2.2	1220	77
250	M3GP 315LKB 2	3GGP311820-...K	2982	96.4	96.7	96.7	0.91	413	7.9	800	2.5	2.7	2.9	1540	77

Equipment protection level and equipment group subdivision must be selected when ordering by selecting appropriate variant code:

334 - Ex t, dust group IIIB T125 Db (non-conductive dust) acc. to IEC/EN60079-31

335 - Ex t, dust group IIIB T125 Dc (non-conductive dust) acc. to IEC/EN60079-31

336 - Ex t, dust group IIIC T125 Db (conductive dust) acc. to IEC/EN60079-31

337 - Ex t, dust group IIIC T125 Dc (conductive dust) acc. to IEC/EN60079-31

Technical data for Ex t IIIB/IIIC IE3 cast iron motors, 1500 r/min

IP 55 - IC 411 - Insulation class F, temperature rise class B
IE3 efficiency class according to IEC 60034-30-1; 2014

Output kW	Motor type	Product code	Speed r/min	Efficiency IEC 60034-30-1; 2014			Power factor Cosφ	Current		Torque		Moment of inertia J = 1/4 GD ² kgm ²	Weight kg	Sound pressure Level L _{PA} dB	
				Full load 100%	3/4 load 75%	1/2 load 50%		I _N A	I _s /I _N	T _N Nm	T _i /T _N				T _b /T _N
1500 r/min = 4 poles				400 V 50 Hz			CENELEC								
0.25	M3GP 71MD 4	3GGP072340-...L	1416	73.5	75.1	73.8	0.80	0.60	4.8	1.68	2.0	2.6	0.0009	11	45
0.37	M3GP 71MLE 4	3GGP072450-...L	1432	77.3	77.4	74.5	0.76	0.90	5.8	2.5	2.5	3.1	0.00122	15	49
0.55	M3GP 80MLD 4	3GGP082440-...K	1439	82.9	84.2	83.5	0.81	1.18	6.3	3.6	2.7	3.3	0.0028	20	45
0.75	M3GP 80MLG 4	3GGP082470-...K	1445	84.1	85.0	83.8	0.79	1.62	6.9	5.0	3.1	3.8	0.0033	22	57
1.1	M3GP 90LC 4	3GGP092530-...K	1444	87.1	87.5	86.4	0.79	2.3	7.2	7.3	2.7	3.7	0.0067	33	56
1.5	M3GP 90LD 4	3GGP092540-...K	1442	85.3	86.4	85.8	0.78	3.1	7.8	10.0	3.4	4.5	0.0072	34	56
2.2	M3GP 100LKA 4	3GGP102810-...K	1452	89.4	90.3	90.2	0.83	4.2	7.4	14.5	3.4	4.1	0.0146	49	56
3	M3GP 100LKB 4	3GGP102820-...K	1452	89.4	90.5	90.5	0.83	5.8	7.5	19.7	2.3	4.0	0.0146	49	58
4	M3GP 112MG 4	3GGP112370-...K	1454	88.6	89.5	89.1	0.75	8.7	7.5	26.3	3.5	3.7	0.0176	52	59
5.5	M3GP 132SMF 4	3GGP132260-...K	1462	90.7	91.6	91.6	0.81	10.8	7.3	35.9	2.4	3.4	0.0401	81	67
7.5	M3GP 132SMG 4	3GGP132270-...K	1457	90.4	91.5	91.7	0.81	14.8	7.3	49.1	2.4	3.4	0.0401	81	64
11	M3GP 160MLA 4	3GGP162410-...K	1473	92.2	93.0	92.7	0.84	20.4	7.7	71.3	2.6	2.9	0.108	188	62
15	M3GP 160MLB 4	3GGP162420-...K	1474	92.6	93.4	93.2	0.84	27.8	7.9	97.1	2.8	3.3	0.125	187	62
18.5	M3GP 180MLA 4	3GGP182410-...K	1481	93.3	94.0	93.8	0.82	34.9	7.6	119	3.0	3.1	0.217	235	62
22	M3GP 180MLB 4	3GGP182420-...K	1480	93.3	94.1	94.1	0.82	41.5	8.2	141	2.8	3.1	0.217	235	62
30	M3GP 200MLA 4	3GGP202410-...K	1484	94.4	94.9	94.7	0.84	54.6	8.3	193	3.0	3.3	0.366	319	63
37	M3GP 225SMA 4	3GGP222210-...K	1482	94.9	95.5	95.4	0.86	65.4	7.7	238	2.8	3.1	0.536	398	66
45	M3GP 225SMB 4	3GGP222220-...K	1482	95.2	95.7	95.6	0.85	80.2	7.9	289	2.8	3.2	0.536	398	66
55	M3GP 250SMA 4	3GGP252210-...K	1485	95.4	95.9	95.7	0.85	97.8	7.9	353	3.0	3.3	0.933	476	67
75	M3GP 280SMB 4	3GGP282220-...K	1486	95.9	96.2	96.1	0.85	134	7.4	482	2.5	2.8	1.5	665	72
90	M3GP 280SMC 4	3GGP282230-...K	1487	96.0	96.2	95.9	0.85	161	7.9	578	2.9	3.0	1.85	725	72
110	M3GP 315SMC 4	3GGP312230-...K	1491	96.2	96.5	96.1	0.85	194	7.8	704	2.4	3.1	2.9	1000	68
132	M3GP 315SMD 4	3GGP312240-...K	1490	96.3	96.6	96.2	0.85	234	7.9	846	2.6	3.2	3.2	1065	68
160	M3GP 315MLB 4	3GGP312420-...K	1490	96.5	96.7	96.4	0.86	278	7.9	1026	2.7	3.0	3.9	1220	68
200	M3GP 355SMA 4	3GGP352210-...K	1491	96.6	96.7	96.4	0.87	345	7.3	1282	2.1	2.7	5.9	1610	74
250	M3GP 355SMB 4	3GGP352220-...K	1491	96.6	96.8	96.5	0.87	433	7.8	1601	2.5	2.9	6.9	1780	74
315	M3GP 355SMC 4	3GGP352230-...K	1490	96.6	96.8	96.5	0.85	554	7.4	2017	2.8	2.9	7.2	1820	74
355	M3GP 355MLA 4	3GGP352410-...K	1491	96.6	96.9	96.5	0.87	616	7.9	2274	2.7	2.9	8.4	2140	78
400	M3GP 355MLB 4	3GGP352420-...K	1489	96.0	96.0	95.5	0.85	705	6.8	2565	2.3	2.6	8.4	2140	78
450	M3GP 355MLC 4	3GGP352430-...K	1490	96.0	96.1	95.6	0.86	780	6.9	2884	2.3	2.9	8.4	2140	78
500	M3GP 355LKA 4	3GGP352810-...K	1490	96.0	96.0	95.3	0.86	865	6.8	3204	2.0	3.0	10	2500	78
560	M3GP 400LA 4	3GGP402510-...K	1491	96.0	96.0	95.4	0.85	982	7.4	3586	2.4	2.8	15	3200	78
560	M3GP 400LKA 4	3GGP402810-...K	1491	96.0	96.0	95.4	0.85	982	7.4	3586	2.4	2.8	15	3200	78
630	M3GP 400LB 4	3GGP402520-...K	1491	96.0	96.0	95.4	0.86	1077	7.6	4034	2.2	2.9	16	3300	78
630	M3GP 400LKB 4	3GGP402820-...K	1491	96.0	96.0	95.4	0.86	1077	7.6	4034	2.2	2.9	16	3300	78
680	M3GP 400LKC 4	3GGP402830-...K	1491	96.0	96.0	95.5	0.85	1206	7.7	4354	2.5	3.1	17	3400	78
710	M3GP 400LC 4	3GGP402530-...K	1491	96.0	96.0	95.5	0.85	1227	7.6	4547	2.4	3.0	17	3400	78
800	M3GP 450LA 4	3GGP452510-...K	1491	96.0	96.0	95.4	0.86	1396	7.0	5121	1.3	2.8	23	4050	85
900	M3GP 450LB 4	3GGP452520-...K	1492	96.0	95.9	95.2	0.86	1573	7.0	5761	1.3	2.8	25	4350	85
1000	M3GP 450LC 4	3GGP452530-...K	1491	96.0	96.0	95.3	0.86	1724	6.8	6404	1.3	2.7	30	4700	85

Equipment protection level and equipment group subdivision must be selected when ordering by selecting appropriate variant code:

334 - Ex t, dust group IIIB T125 Db (non-conductive dust) acc. to IEC/EN60079-31

335 - Ex t, dust group IIIB T125 Dc (non-conductive dust) acc. to IEC/EN60079-31

336 - Ex t, dust group IIIC T125 Db (conductive dust) acc. to IEC/EN60079-31

337 - Ex t, dust group IIIC T125 Dc (conductive dust) acc. to IEC/EN60079-31

Technical data for Ex t IIIB/IIIC

IE3 cast iron motors, 1500 r/min

IP 55 - IC 411 - Insulation class F, temperature rise class B
IE3 efficiency class according to IEC 60034-30-1; 2014

Output kW	Motor type	Product code	Speed r/min	Efficiency IEC 60034-30-1; 2014			Power factor Cosφ	Current			Torque		Moment of inertia J = 1/4 GD ² kgm ²	Weight kg	Sound pressure Level L _{PA} dB
				Full load 100%	3/4 load 75%	1/2 load 50%		I _N A	I _s /I _N	T _N Nm	T _i /T _N	T _b /T _N			
1500 r/min = 4 poles				400 V 50 Hz				High-output							
200	M3GP 315LKB 4	3GGP312820-**-K	1490	96.6	96.8	96.7	0.87	346	7.6	1282	2.5	2.9	5	1480	74
250	M3GP 315LKC 4	3GGP312830-**-K	1490	96.6	96.9	96.8	0.87	432	7.8	1601	2.3	3.0	5.5	1600	74

Equipment protection level and equipment group subdivision must be selected when ordering by selecting appropriate variant code:

334 - Ex t, dust group IIIB T125 Db (non-conductive dust) acc. to IEC/EN60079-31

335 - Ex t, dust group IIIB T125 Dc (non-conductive dust) acc. to IEC/EN60079-31

336 - Ex t, dust group IIIC T125 Db (conductive dust) acc. to IEC/EN60079-31

337 - Ex t, dust group IIIC T125 Dc (conductive dust) acc. to IEC/EN60079-31

Technical data for Ex t IIIB/IIIC IE3 cast iron motors, 1000 r/min

IP 55 - IC 411 - Insulation class F, temperature rise class B
IE3 efficiency class according to IEC 60034-30-1; 2014

Output kW	Motor type	Product code	Speed r/min	Efficiency IEC 60034-30-1; 2014			Power factor Cosφ	Current		Torque		Moment of inertia J = 1/4 GD ² kgm ²	Weight kg	Sound pressure Level L _{PA} dB	
				Full load 100%	3/4 load 75%	1/2 load 50%		I _N A	I _s /I _N	T _N Nm	T _i /T _N				T _b /T _N
1000 r/min = 6 poles				400 V 50 Hz				CENELEC							
0.18	M3GP 71ME 6	3GGP073350-...L	887	63.9	64.3	59.8	0.74	0.57	3.2	1.90	1.9	2.2	0.0009	10	45
0.25	M3GP 80MA 6	3GGP083310-...K	937	73.3	72.2	67.6	0.64	0.76	2.6	2.5	1.4	2.0	0.0019	14	47
0.37	M3GP 80MD 6	3GGP083340-...K	930	77.9	78.6	76.7	0.72	0.95	3.3	3.8	1.5	1.9	0.0028	16	47
0.55	M3GP 80MLG 6	3GGP083470-...K	937	80.4	81.0	79.5	0.63	1.56	4.4	5.6	3.4	3.8	0.0044	21	47
0.75	M3GP 90LG 6	3GGP093570-...K	938	81.5	82.8	82.2	0.74	1.80	4.8	7.7	2.4	2.7	0.0072	34	44
1.1	M3GP 100LKG 6	3GGP103870-...K	969	84.4	84.5	82.8	0.68	2.6	4.1	10.9	1.6	2.2	0.0025	47	49
1.5	M3GP 112MH 6	3GGP113380-...K	972	85.8	85.6	83.6	0.64	3.8	7.0	14.7	2.7	4.5	0.0196	53	66
2.2	M3GP 132SMC 6	3GGP133230-...K	978	87.3	87.5	86.1	0.69	5.1	5.4	21.5	2.0	2.6	0.0416	81	57
3	M3GP 132SMD 6	3GGP133240-...K	977	88.5	88.8	87.5	0.69	6.9	5.9	29.0	1.9	3.3	0.0416	82	57
4	M3GP 132SMG 6	3GGP133270-...K	974	89.4	89.9	89.3	0.69	9.3	5.6	38.7	2.2	2.8	0.0416	82	57
5.5	M3GP 132SMH 6	3GGP133280-...K	966	89.6	90.4	90.2	0.73	12.1	5.0	54.1	1.8	2.7	0.0654	79	57
7.5	M3GP 160MLA 6	3GGP163410-...K	980	90.8	91.5	91.0	0.78	15.2	7.9	73.0	1.7	3.3	0.114	172	59
11	M3GP 160MLB 6	3GGP163420-...K	979	91.2	91.8	91.1	0.74	23.5	8.5	107	2.2	3.9	0.131	199	59
15	M3GP 180MLA 6	3GGP183410-...K	981	92.2	92.5	91.5	0.77	30.4	5.5	146	1.7	2.7	0.225	234	59
18.5	M3GP 200MLA 6	3GGP203410-...K	990	92.8	93.2	92.6	0.77	37.3	7.5	178	2.6	3.2	0.448	291	63
22	M3GP 200MLB 6	3GGP203420-...K	990	93.3	93.7	93.1	0.79	43.0	7.8	212	2.6	3.2	0.531	318	63
30	M3GP 225SMA 6	3GGP223210-...K	989	94.1	94.7	94.5	0.81	56.8	7.9	289	2.8	3.1	0.813	392	63
37	M3GP 250SMA 6	3GGP253210-...K	991	94.4	94.9	94.7	0.83	68.0	7.7	356	2.7	2.9	1.49	467	63
45	M3GP 280SMB 6	3GGP283220-...K	992	94.7	95.1	94.6	0.85	80.9	7.5	434	2.4	2.6	2.2	680	65
55	M3GP 280SMC 6	3GGP283230-...K	990	95.0	95.4	95.0	0.85	99.4	6.8	506	2.4	2.6	2.85	725	65
75	M3GP 315SMC 6	3GGP313230-...K	994	95.3	95.6	95.2	0.83	138	7.0	721	2.2	2.8	4.9	1000	67
90	M3GP 315SMD 6	3GGP313240-...K	994	95.5	95.8	95.4	0.81	170	7.2	864	2.4	2.9	4.9	1040	67
110	M3GP 315MLB 6	3GGP313420-...K	994	95.7	95.9	95.7	0.83	202	6.9	1058	2.3	2.7	6.3	1200	68
132	M3GP 315LKA 6	3GGP313810-...K	993	95.9	96.1	95.9	0.82	243	6.9	1269	2.4	2.7	7.3	1410	68
160	M3GP 355SMB 6	3GGP353220-...K	995	96.1	96.1	95.6	0.82	294	7.0	1536	2.1	2.7	9.7	1680	73
200	M3GP 355SMC 6	3GGP353230-...K	995	96.2	96.4	96.1	0.82	367	7.3	1920	2.3	2.8	11.3	1820	73
250	M3GP 355MLB 6	3GGP353420-...K	995	96.4	96.6	96.5	0.83	456	7.1	2399	2.3	2.7	13.5	2180	73
315	M3GP 355LKA 6	3GGP353810-...K	994	96.5	96.7	96.4	0.83	576	6.9	3026	2.3	2.6	15.5	2500	76
355	M3GP 355LKB 6	3GGP353820-...K	995	96.5	96.6	96.1	0.81	668	7.7	3407	2.7	2.9	16.5	2600	76
400	M3GP 400LA 6	3GGP403510-...K	993	95.8	95.8	95.1	0.82	731	7.1	3846	2.3	2.7	17	2900	76
400	M3GP 400LKA 6	3GGP403810-...K	993	95.8	95.8	95.1	0.82	731	7.1	3846	2.3	2.7	17	2900	76
450	M3GP 400LB 6	3GGP403520-...K	994	95.8	95.8	95.2	0.82	819	7.4	4323	2.4	2.8	20.5	3150	76
450	M3GP 400LKB 6	3GGP403820-...K	994	95.8	95.8	95.2	0.82	819	7.4	4323	2.4	2.8	20.5	3150	76
500	M3GP 400LC 6	3GGP403530-...K	993	95.8	95.6	95.2	0.83	891	7.2	4809	2.5	2.7	22	3300	76
500	M3GP 400LKC 6	3GGP403830-...K	993	95.8	95.6	95.2	0.83	891	7.2	4809	2.5	2.7	22	3300	76
560	M3GP 400LD 6	3GGP403540-...K	993	95.8	95.8	95.2	0.85	984	7.4	5386	2.4	2.8	24	3400	77
560	M3GP 400LKD 6	3GGP403840-...K	993	95.8	95.8	95.2	0.85	984	7.4	5386	2.4	2.8	24	3400	77
630	M3GP 450LA 6	3GGP453510-...K	994	95.8	95.9	95.3	0.84	1127	6.5	6053	1.1	2.5	31	4150	81
710	M3GP 450LB 6	3GGP453520-...K	995	95.8	95.9	95.3	0.85	1244	7.0	6814	1.3	2.5	37	4500	81
800	M3GP 450LC 6	3GGP453530-...K	995	95.8	95.8	95.1	0.84	1415	7.2	7677	1.3	2.7	41	4800	81

Equipment protection level and equipment group subdivision must be selected when ordering by selecting appropriate variant code:

- 334 - Ex t, dust group IIIB T125 Db (non-conductive dust) acc. to IEC/EN60079-31
- 335 - Ex t, dust group IIIB T125 Dc (non-conductive dust) acc. to IEC/EN60079-31
- 336 - Ex t, dust group IIIC T125 Db (conductive dust) acc. to IEC/EN60079-31
- 337 - Ex t, dust group IIIC T125 Dc (conductive dust) acc. to IEC/EN60079-31

Technical data for Ex t IIIB/IIIC IE3 cast iron motors, 1000 r/min

IP 55 - IC 411 - Insulation class F, temperature rise class B
IE3 efficiency class according to IEC 60034-30-1; 2014

Output kW	Motor type	Product code	Speed r/min	Efficiency IEC 60034-30-1; 2014			Power factor Cosφ	Current			Torque		Moment of inertia J = 1/4 GD ² kgm ²	Weight kg	Sound pressure Level L _{PA} dB
				Full load 100%	3/4 load 75%	1/2 load 50%		I _N A	I _s /I _N	T _N Nm	T _i /T _N	T _b /T _N			
1000 r/min = 6 poles			400 V 50 Hz			High-output									
160	M3GP 315LKC 6	3GGP313830-..K	994	96.1	96.3	96.2	0.82	297	7.4	1537	2.7	2.9	9.2	1600	68

Equipment protection level and equipment group subdivision must be selected when ordering by selecting appropriate variant code:

334 - Ex t, dust group IIIB T125 Db (non-conductive dust) acc. to IEC/EN60079-31

335 - Ex t, dust group IIIB T125 Dc (non-conductive dust) acc. to IEC/EN60079-31

336 - Ex t, dust group IIIC T125 Db (conductive dust) acc. to IEC/EN60079-31

337 - Ex t, dust group IIIC T125 Dc (conductive dust) acc. to IEC/EN60079-31

Technical data for Ex t IIIB/IIIC IE3 cast iron motors, 750 r/min

IP 55 - IC 411 - Insulation class F, temperature rise class B
IE3 efficiency class according to IEC 60034-30-1; 2014

Output kW	Motor type	Product code	Speed r/min	Efficiency IEC 60034-30-1; 2014			Power factor Cosφ	Current		Torque		Moment of inertia J = 1/4 GD ² kgm ²	Weight kg	Sound pressure Level L _{PA} dB	
				Full load 100%	3/4 load 75%	1/2 load 50%		I _N A	I _s /I _N	T _N Nm	T _i /T _N				T _b /T _N
750 r/min = 8 poles				400 V 50 Hz				CENELEC							
0.12	M3GP 71ME 8	3GGP074350-...L	659	50.7	48.9	41.9	0.68	0.49	2.5	1.70	1.9	2.1	0.00107	11	43
0.18	M3GP 80MF 8	3GGP084360-...L	679	58.8	57.3	51.7	0.55	0.80	2.2	2.6	1.3	1.9	0.0035	18	45
0.25	M3GP 80MLG 8	3GGP084470-...L	674	64.1	66.4	64.1	0.58	0.92	2.3	3.5	1.3	1.9	0.0044	21	50
0.37	M3GP 90SLF 8	3GGP094060-...L	710	69.3	67.8	62.5	0.54	1.37	3.3	5.0	2.3	3.3	0.0056	28	50
0.55	M3GP 90LG 8	3GGP094570-...L	710	73.0	70.8	64.6	0.53	2.0	4.1	7.7	2.5	3.2	0.0072	32	53
0.75	M3GP 100LKA 8	3GGP104810-...K	710	75.0	74.5	70.5	0.65	2.1	4.4	10.0	2.4	2.8	0.00855	37	53
1.1	M3GP 100LKB 8	3GGP104820-...K	703	77.7	77.7	74.7	0.65	3.1	4.4	14.9	2.7	2.9	0.0128	45	53
1.5	M3GP 112MC 8	3GGP114330-...K	717	79.7	80.1	78.8	0.62	4.1	4.3	19.9	1.8	2.6	0.0194	53	55
2.2	M3GP 132SMA 8	3GGP134210-...K	725	81.9	82.3	80.2	0.64	5.8	5.2	28.9	2.0	3.0	0.0291	66	57
3	M3GP 132SMG 8	3GGP134270-...K	723	83.5	84.1	82.8	0.66	7.5	4.8	39.6	1.8	2.8	0.0375	76	57
4	M3GP 160MLA 8	3GGP164410-...K	734	84.8	85.1	83.2	0.65	10.3	4.5	52.0	1.8	2.3	0.091	148	59
5.5	M3GP 160MLB 8	3GGP164420-...K	732	86.2	87.1	86.1	0.69	13.0	5.0	71.7	2.0	2.4	0.091	150	59
7.5	M3GP 160MLC 8	3GGP164430-...K	733	87.3	88.2	87.2	0.69	17.6	5.1	97.7	2.0	2.4	0.12	232	59
11	M3GP 180MLA 8	3GGP184410-...K	731	88.6	89.2	88.4	0.70	25.3	5.0	144	2.1	2.1	0.2	219	59
15	M3GP 200MLA 8	3GGP204410-...K	737	89.6	90.5	90.1	0.74	32.5	5.2	194	2.1	2.4	0.45	290	60
18.5	M3GP 225SMA 8	3GGP224210-...K	736	90.1	90.8	90.2	0.74	39.8	5.2	240	2.0	2.3	0.669	350	63
22	M3GP 225SMB 8	3GGP224220-...K	736	90.6	91.6	91.5	0.73	47.5	5.3	285	2.3	2.5	0.722	363	63
30	M3GP 250SMA 8	3GGP254210-...K	741	91.3	91.7	91.0	0.71	67.0	5.6	386	2.7	2.7	1.4	440	63
37	M3GP 280SMA 8	3GGP284210-...K	741	91.8	92.0	91.3	0.79	72.6	7.3	476	1.7	3.0	1.85	605	65
45	M3GP 280SMB 8	3GGP284220-...K	741	92.2	92.3	91.7	0.78	89.2	7.6	579	1.8	3.1	2.2	645	65
55	M3GP 315SMA 8	3GGP314210-...K	742	92.5	93.1	92.5	0.80	106	7.1	707	1.6	2.7	3.2	830	62
75	M3GP 315SMB 8	3GGP314220-...K	741	93.1	93.2	93.1	0.82	146	7.1	966	1.7	2.7	4.1	930	62
90	M3GP 315SMC 8	3GGP314230-...K	741	93.4	93.7	93.4	0.82	170	7.4	1159	1.8	2.7	4.9	1000	64
110	M3GP 315MLA 8	3GGP314410-...K	740	93.7	94.0	94.1	0.83	211	7.3	1419	1.8	2.7	5.8	1150	72
132	M3GP 355SMA 8	3GGP354210-...K	744	94.0	93.9	93.4	0.79	256	7.5	1694	1.5	2.6	7.9	1520	69
160	M3GP 355SMB 8	3GGP354220-...K	744	94.3	94.3	93.8	0.79	293	7.6	1926	1.6	2.6	9.7	1680	69
200	M3GP 355SMC 8	3GGP354230-...K	742	94.6	95.0	94.8	0.79	385	7.4	2576	1.6	2.6	11.3	1820	69
250	M3GP 355MLB 8	3GGP354420-...K	743	94.6	94.7	94.1	0.80	472	7.5	3213	1.6	2.7	13.5	2180	72
315	M3GP 400LA 8	3GGP404510-...K	744	94.6	94.5	94.0	0.80	592	7.0	4043	1.2	2.6	17	2900	71
315	M3GP 400LKA 8	3GGP404810-...K	744	94.6	94.5	94.0	0.80	592	7.0	4043	1.2	2.6	17	2900	71
355	M3GP 400LB 8	3GGP404520-...K	743	94.6	94.9	94.6	0.83	641	6.8	4562	1.2	2.5	21	3200	71
355	M3GP 400LKB 8	3GGP404820-...K	743	94.6	94.9	94.6	0.83	641	6.8	4562	1.2	2.5	21	3200	71
400	M3GP 400LC 8	3GGP404530-...K	744	94.6	94.9	94.3	0.81	735	6.0	5134	1.3	2.7	24	3400	71
400	M3GP 400LKC 8	3GGP404830-...K	744	94.6	94.9	94.3	0.81	735	6.0	5134	1.3	2.7	24	3400	71
450	M3GP 450LA 8	3GGP454510-...K	744	94.6	95.0	94.6	0.83	813	6.0	5775	1.0	2.5	26	3750	80
500	M3GP 450LB 8	3GGP454520-...K	744	94.6	94.7	94.5	0.83	902	6.4	6417	1.0	2.6	29	4000	80
560	M3GP 450LC 8	3GGP454530-...K	744	94.6	94.9	94.2	0.81	1038	7.0	7188	1.2	2.9	35	4350	80
630	M3GP 450LD 8	3GGP454540-...K	745	94.6	94.8	94.0	0.82	1162	7.6	8075	1.3	3.2	41	4800	80

Equipment protection level and equipment group subdivision must be selected when ordering by selecting appropriate variant code:

- 334 - Ex t, dust group IIIB T125 Db (non-conductive dust) acc. to IEC/EN60079-31
- 335 - Ex t, dust group IIIB T125 Dc (non-conductive dust) acc. to IEC/EN60079-31
- 336 - Ex t, dust group IIIC T125 Db (conductive dust) acc. to IEC/EN60079-31
- 337 - Ex t, dust group IIIC T125 Dc (conductive dust) acc. to IEC/EN60079-31

Technical data for Ex t IIIB/IIIC IE2 cast iron motors, 3000 r/min

IP 55 - IC 411 - Insulation class F, temperature rise class B
IE2 efficiency class according to IEC 60034-30-1; 2014

Output kW	Motor type	Product code	Speed r/min	Efficiency IEC 60034-30-1; 2014			Power factor Cosφ	Current			Torque		Moment of inertia J = 1/4 GD ² kgm ²	Weight kg	Sound pressure Level L _{PA} dB
				Full load 100%	3/4 load 75%	1/2 load 50%		I _N A	I _s /I _N	T _N Nm	T _i /T _N	T _b /T _N			
3000 r/min = 2 poles				400 V 50 Hz				CENELEC							
0.37	M3GP 71MA 2	3GGP071321...B	2785	69.5	70.8	67.8	0.79	0.91	4.6	1.26	2.5	2.8	0.0004	11	57
0.55	M3GP 71MB 2	3GGP071322...B	2790	74.1	75.4	73.4	0.79	1.29	5.1	1.88	3.1	3.1	0.0005	11	57
0.75	M3GP 80MB 2	3GGP081322...B	2895	80.6	79.5	75.6	0.74	1.80	7.7	2.4	4.2	4.2	0.001	16	57
1.1	M3GP 80MC 2	3GGP081323...B	2870	81.8	81.7	79.0	0.80	2.5	7.5	3.6	3.7	4.6	0.0012	18	60
1.5	M3GP 90SLB 2	3GGP091322...B	2900	82.2	82.9	81.3	0.89	2.9	7.5	4.9	2.5	2.6	0.00254	24	69
2.2	M3GP 90SLC 2	3GGP091323...B	2885	83.2	85.5	84.3	0.88	4.2	6.8	7.2	1.9	2.5	0.0028	25	64
3	M3GP 100LB 2	3GGP101322...B	2925	85.2	84.9	82.7	0.87	5.8	9.1	9.7	3.1	3.5	0.0053	36	68
4	M3GP 112MB 2	3GGP111322...B	2895	86.1	87.0	86.6	0.89	7.5	8.7	13.1	3.3	3.5	0.00575	37	70
5.5	M3GP 132SMB 2	3GGP131322...B	2865	87.7	88.4	87.7	0.86	10.0	7.0	18.3	2.5	2.7	0.0128	68	70
7.5	M3GP 132SMC 2	3GGP131324...B	2890	88.2	88.8	87.6	0.89	13.7	7.3	24.7	2.5	3.6	0.0136	70	70
11	M3GP 160MLA 2	3GGP161410...D	2931	90.1	90.4	89.3	0.89	20.2	6.7	35.8	2.5	3.2	0.043	139	71
15	M3GP 160MLB 2	3GGP161420...D	2929	91.2	91.6	90.8	0.89	27.0	7.2	48.9	2.9	3.4	0.052	149	71
18.5	M3GP 160MLC 2	3GGP161430...D	2934	91.6	92.4	92.3	0.90	32.4	7.4	60.3	3.1	3.5	0.062	159	69
22	M3GP 180MLA 2	3GGP181410...D	2938	91.7	92.3	91.8	0.90	39.1	7.0	71.4	2.5	3.2	0.089	199	69
30	M3GP 200MLA 2	3GGP201410...D	2956	92.8	93.3	92.6	0.88	52.7	7.0	96.9	2.4	3.2	0.15	275	74
37	M3GP 200MLC 2	3GGP201430...D	2954	93.6	94.0	93.4	0.89	64.7	7.5	120	2.4	3.2	0.19	304	75
45	M3GP 225SMB 2	3GGP221220...D	2968	93.8	93.9	93.0	0.87	78.8	7.2	144	2.4	3.0	0.26	357	76
55	M3GP 250SMA 2	3GGP251210...D	2975	94.2	94.1	93.1	0.89	95.1	7.2	176	2.0	3.1	0.49	445	75
75	¹⁾ M3GP 280SMA 2	3GGP281210...G	2977	94.3	93.8	92.3	0.88	131	7.6	240	2.1	3.0	0.8	625	77
90	M3GP 280SMB 2	3GGP281220...G	2976	94.6	94.7	93.8	0.89	154	7.4	288	2.1	2.9	0.9	665	77
110	M3GP 315SMA 2	3GGP311210...G	2982	94.9	94.4	92.9	0.86	197	7.4	352	2.2	3.2	1.2	880	78
132	¹⁾ M3GP 315SMB 2	3GGP311220...G	2982	95.1	94.8	93.6	0.88	227	7.4	422	2.2	3.0	1.4	940	78
160	M3GP 315SMC 2	3GGP311230...G	2981	95.4	95.2	94.2	0.89	271	7.5	512	2.3	3.0	1.7	1025	78
200	¹⁾ M3GP 315MLA 2	3GGP311410...G	2980	95.7	95.7	94.9	0.90	335	7.7	640	2.6	3.0	2.1	1190	78
250	M3GP 355SMA 2	3GGP351210...G	2984	95.7	95.5	94.5	0.89	423	7.7	800	2.1	3.3	3	1600	83
315	¹⁾ M3GP 355SMB 2	3GGP351220...G	2980	95.7	95.6	94.9	0.89	531	7.0	1009	2.1	3.0	3.4	1680	83
355	M3GP 355SMC 2	3GGP351230...G	2984	95.7	95.7	94.9	0.88	603	7.2	1136	2.2	3.0	3.6	1750	83
400	¹⁾ M3GP 355MLA 2	3GGP351410...G	2982	96.5	96.3	95.6	0.88	677	7.1	1280	2.3	2.9	4.1	2000	83
450	M3GP 355MLB 2	3GGP351420...G	2983	96.5	96.5	95.7	0.90	743	7.9	1440	2.2	2.9	4.3	2080	83
500	¹⁾ M3GP 355LKA 2	3GGP351810...G	2982	96.5	96.5	96.0	0.90	827	7.5	1601	2.0	3.9	4.8	2320	83
560	²⁾ M3GP 400LA 2	3GGP401510...G	2988	96.5	96.5	95.7	0.89	934	7.8	1789	2.5	3.7	7.9	2950	82
560	M3GP 400LKA 2	3GGP401810...G	2988	96.5	96.5	95.7	0.89	934	7.8	1789	2.5	3.7	7.9	2950	82
560	M3GP 355LKB 2	3GGP351820...G	2983	97.0	97.0	96.5	0.90	925	8.0	1792	2.2	4.1	5.2	2460	83
630	M3GP 400LB 2	3GGP401520...G	2987	96.5	96.2	95.6	0.89	1049	7.6	2014	2.6	3.7	8.2	3050	82
630	²⁾ M3GP 400LKB 2	3GGP401820...G	2987	96.5	96.2	95.6	0.89	1049	7.6	2014	2.6	3.7	8.2	3050	82
710	²⁾ M3GP 400LC 2	3GGP401530...G	2987	96.5	96.3	95.7	0.89	1178	7.2	2270	2.6	3.4	9.3	3300	82
710	M3GP 400LKC 2	3GGP401830...G	2987	96.5	96.3	95.7	0.89	1178	7.2	2270	2.6	3.4	9.3	3300	82
800	²⁾ M3GP 450LA 2	3GGP451510...G	2990	96.5	96.2	95.4	0.87	1362	7.8	2555	1.3	3.4	12.2	4000	
900	²⁾ M3GP 450LB 2	3GGP451520...G	2990	96.5	96.2	95.5	0.87	1534	7.6	2874	1.5	3.1	13.5	4200	

¹⁾ -3dB(A) sound pressure level reduction with unidirectional fan construction. Direction of rotation must be stated when ordering, see variant codes 044 and 045

²⁾ Unidirectional fan construction as standard. Direction of rotation must be stated when ordering, see variant codes 044 and 045
Equipment protection level and equipment group subdivision must be selected when ordering by selecting appropriate variant code:
334 - Ex t, dust group IIIB T125 Db (non-conductive dust) acc. to IEC/EN60079-31
335 - Ex t, dust group IIIB T125 Dc (non-conductive dust) acc. to IEC/EN60079-31
336 - Ex t, dust group IIIC T125 Db (conductive dust) acc. to IEC/EN60079-31
337 - Ex t, dust group IIIC T125 Dc (conductive dust) acc. to IEC/EN60079-31

Technical data for Ex t IIIB/IIIC IE2 cast iron motors, 3000 r/min

IP 55 - IC 411 - Insulation class F, temperature rise class B
IE2 efficiency class according to IEC 60034-30-1; 2014

Output kW	Motor type	Product code	Speed r/min	Efficiency IEC 60034-30-1; 2014			Power factor Cosφ	Current		Torque		Moment of inertia J = 1/4 GD ² kgm ²	Weight kg	Sound pressure Level L _{PA} dB	
				Full load 100%	3/4 load 75%	1/2 load 50%		I _N A	I _s /I _N	T _N Nm	T _i /T _N				T _b /T _N
3000 r/min = 2 poles				400 V 50 Hz				High-output							
22	M3GP 160MLD 2	3GGP161440...D	2929	91.2	91.9	91.4	0.90	38.3	7.5	71.7	3.1	3.3	0.07	166	77
30	M3GP 180MLB 2	3GGP181420...D	2943	92.5	93.2	92.6	0.90	52.2	7.0	97.2	2.3	3.2	0.13	236	78
37	M3GP 180MLC 2	3GGP181430...D	2950	92.8	93.1	92.8	0.90	64.9	8.1	120	3.3	3.7	0.13	237	77
45	M3GP 200MLE 2	3GGP201450...D	2945	93.3	93.5	93.1	0.88	79.4	7.3	145	2.9	3.1	0.22	312	79
55	M3GP 225SMC 2	3GGP221230...D	2965	93.9	94.2	93.5	0.88	95.8	7.1	177	2.3	3.0	0.29	377	80
67	M3GP 225SMD 2	3GGP221240...D	2966	93.9	93.9	93.0	0.86	120	7.4	215	2.5	3.2	0.31	388	78
75	M3GP 250SMB 2	3GGP251220...D	2969	93.8	93.9	93.1	0.89	129	7.9	241	2.2	3.1	0.57	487	80
90	M3GP 250SMC 2	3GGP251230...D	2965	94.4	94.5	93.9	0.89	153	7.7	289	2.5	3.0	0.59	500	80
110 ¹⁾	M3GP 280SMC 2	3GGP281230...G	2978	95.1	95.1	94.5	0.90	186	7.9	352	2.4	3.0	1.15	725	77
132	M3GP 280MLA 2	3GGP281410...G	2977	95.3	95.3	94.8	0.90	221	7.5	423	2.5	3.0	1.4	840	81
160	M3GP 280MLB 2	3GGP281420...G	2976	95.5	95.7	95.3	0.91	265	7.6	513	2.8	3.0	1.55	890	81

¹⁾ -3dB(A) sound pressure level reduction with unidirectional fan construction. Direction of rotation must be stated when ordering, see variant codes 044 and 045.

Equipment protection level and equipment group subdivision must be selected when ordering by selecting appropriate variant code:

334 - Ex t, dust group IIIB T125 Db (non-conductive dust) acc. to IEC/EN60079-31

335 - Ex t, dust group IIIB T125 Dc (non-conductive dust) acc. to IEC/EN60079-31

336 - Ex t, dust group IIIC T125 Db (conductive dust) acc. to IEC/EN60079-31

337 - Ex t, dust group IIIC T125 Dc (conductive dust) acc. to IEC/EN60079-31

Technical data for Ex t IIIB/IIIC IE2 cast iron motors, 1500 r/min

IP 55 - IC 411 - Insulation class F, temperature rise class B
IE2 efficiency class according to IEC 60034-30-1; 2014

Output kW	Motor type	Product code	Speed r/min	Efficiency IEC 60034-30-1; 2014			Power factor Cosφ	Current		Torque		Moment of inertia J = 1/4 GD ² kgm ²	Weight kg	Sound pressure Level L _{PA} dB	
				Full load 100%	3/4 load 75%	1/2 load 50%		I _N A	I _s /I _N	T _N Nm	T _i /T _N				T _b /T _N
1500 r/min = 4 poles				400 V 50 Hz			CENELEC								
0.25	M3GP 71MA 4	3GGP072321...B	1430	68.5	66.8	59.9	0.67	0.76	4.7	1.67	2.2	3.0	0.0006	10	45
0.37	M3GP 71MB 4	3GGP072322...B	1411	72.7	73.3	69.9	0.74	0.96	5.2	2.5	2.6	2.9	0.001	12	45
0.55	M3GP 80MA 4	3GGP082321...B	1406	77.1	78.6	76.8	0.78	1.29	5.4	3.7	2.8	2.9	0.0022	18	50
0.75	M3GP 80MD 4	3GGP082324...B	1430	81.0	81.0	78.2	0.73	1.82	6.9	5.0	3.7	4.8	0.002	17	50
1.1	M3GP 90SLB 4	3GGP092322...B	1435	83.6	84.1	82.4	0.80	2.4	6.5	7.3	2.4	3.4	0.0044	25	50
1.5	M3GP 90SLD 4	3GGP092325...B	1430	84.3	85.1	83.8	0.83	3.0	6.3	10.0	2.7	3.4	0.0053	27	56
2.2	M3GP 100LC 4	3GGP102323...B	1450	85.9	85.1	83.4	0.78	4.6	7.7	14.5	2.7	4.1	0.0095	36	56
3	M3GP 100LD 4	3GGP102324...B	1450	86.8	86.9	85.3	0.79	6.1	7.7	19.8	2.9	3.4	0.011	38	58
4	M3GP 112MB 4	3GGP112322...B	1440	86.6	87.2	86.8	0.82	7.9	7.0	26.5	2.5	2.9	0.0125	44	59
5.5	M3GP 132SMB 4	3GGP132322...B	1460	89.0	89.8	88.9	0.80	10.8	7.1	36.0	2.2	3.1	0.0328	70	67
7.5	M3GP 132SMC 4	3GGP132323...B	1450	89.3	90.1	90.0	0.81	14.5	7.2	49.4	2.5	3.5	0.0366	73	64
11	M3GP 160MLC 4	3GGP162430...D	1470	91.2	91.3	90.0	0.82	21.5	8.0	71.5	3.1	3.6	0.096	160	62
15	M3GP 160MLE 4	3GGP162450...D	1467	92.0	92.3	91.8	0.84	28.5	8.0	97.7	3.3	3.2	0.13	183	61
18.5	M3GP 180MLA 4	3GGP182410...D	1474	91.6	92.1	91.5	0.83	35.7	7.2	120	2.6	3.1	0.19	213	62
22	M3GP 180MLB 4	3GGP182420...D	1474	92.2	92.5	91.9	0.82	42.0	7.7	142	2.8	3.4	0.23	232	62
30	M3GP 200MLB 4	3GGP202420...D	1471	92.5	93.2	93.1	0.84	55.0	6.9	194	2.8	2.8	0.34	306	61
37	M3GP 225SMB 4	3GGP222220...D	1480	93.6	93.9	93.4	0.85	69.0	7.1	239	2.8	2.9	0.42	347	67
45	M3GP 225SMC 4	3GGP222230...D	1477	93.8	94.2	94.0	0.86	78.4	6.7	291	2.6	2.7	0.49	379	67
55	M3GP 250SMA 4	3GGP252210...D	1479	94.3	94.3	93.6	0.84	100	7.2	355	2.5	3.1	0.72	436	66
75	M3GP 280SMA 4	3GGP282210...G	1484	94.5	94.7	94.4	0.85	134	6.9	482	2.5	2.8	1.25	625	68
90	M3GP 280SMB 4	3GGP282220...G	1483	94.7	95.0	94.5	0.85	160	7.2	579	2.5	2.7	1.5	665	68
110	M3GP 315SMA 4	3GGP312210...G	1487	95.1	95.1	94.3	0.86	194	7.2	706	2.3	2.8	2.3	900	70
132	M3GP 315SMB 4	3GGP312220...G	1487	95.4	95.4	94.7	0.86	232	7.1	847	2.3	2.7	2.6	960	70
160	M3GP 315SMC 4	3GGP312230...G	1487	95.3	95.3	94.8	0.85	284	7.2	1027	2.4	2.9	2.9	1000	70
200	M3GP 315MLA 4	3GGP312410...G	1486	95.6	95.8	95.5	0.86	351	7.2	1285	2.5	2.9	3.5	1160	70
250	M3GP 355SMA 4	3GGP352210...G	1488	95.9	96.0	95.5	0.85	442	7.1	1604	2.3	2.7	5.9	1610	74
315	M3GP 355SMB 4	3GGP352220...G	1488	95.9	96.2	95.8	0.86	550	7.3	2021	2.3	2.8	6.9	1780	74
350	M3GP 355SMC 4	3GGP352230...G	1487	95.9	95.9	95.7	0.86	612	6.9	2247	2.4	2.7	7.2	1820	78
400	³⁾ M3GP 355MLA 4	3GGP352410...G	1489	96.3	96.3	95.9	0.85	705	6.8	2565	2.3	2.6	8.4	2140	78
450	M3GP 355MLB 4	3GGP352420...G	1490	96.8	96.8	96.3	0.86	784	6.9	2884	2.3	2.9	8.4	2140	78
500	M3GP 355LKA 4	3GGP352810...G	1490	96.7	96.7	96.1	0.86	865	6.8	3204	2.0	3.0	10	2500	78
560	M3GP 400LA 4	3GGP402510...G	1491	96.7	96.7	96.1	0.85	982	7.4	3586	2.4	2.8	15	3200	78
560	M3GP 400LKA 4	3GGP402810...G	1491	96.7	96.7	96.1	0.85	982	7.4	3586	2.4	2.8	15	3200	78
630	³⁾ M3GP 400LB 4	3GGP402520...G	1491	96.7	96.7	96.1	0.87	1077	7.6	4034	2.2	2.9	16	3300	78
630	M3GP 400LKB 4	3GGP402520...G	1491	96.7	96.7	96.1	0.87	1077	7.6	4034	2.2	2.9	16	3300	78
680	M3GP 400LC 4	3GGP402530...G	1492	96.7	96.7	96.2	0.86	1182	7.9	4353	2.5	3.1	17	3400	78
680	³⁾ M3GP 400LKC 4	3GGP402830...G	1492	96.7	96.7	96.2	0.86	1182	7.9	4353	2.5	3.1	17	3400	78
800	M3GP 450LA 4	3GGP452510...G	1491	96.7	96.7	96.1	0.86	1396	7.0	5121	1.3	2.8	23	4050	85
900	M3GP 450LB 4	3GGP452520...G	1492	96.7	96.5	96.0	0.86	1573	7.0	5761	1.3	2.8	25	4350	85
1000	M3GP 450LC 4	3GGP452530...G	1491	96.7	96.7	96.1	0.86	1724	6.8	6404	1.3	2.7	30	4700	85

³⁾ For 400-415 V 50 Hz (380 V 50 Hz voltage code B)

Equipment protection level and equipment group subdivision must be selected when ordering by selecting appropriate variant code:

334 - Ex t, dust group IIIB T125 Db (non-conductive dust) acc. to IEC/EN60079-31

335 - Ex t, dust group IIIB T125 Dc (non-conductive dust) acc. to IEC/EN60079-31

336 - Ex t, dust group IIIC T125 Db (conductive dust) acc. to IEC/EN60079-31

337 - Ex t, dust group IIIC T125 Dc (conductive dust) acc. to IEC/EN60079-31

Technical data for Ex t IIIB/IIIC

IE2 cast iron motors, 1500 r/min

IP 55 - IC 411 - Insulation class F, temperature rise class B
IE2 efficiency class according to IEC 60034-30-1; 2014

Output kW	Motor type	Product code	Speed r/min	Efficiency IEC 60034-30-1; 2014			Power factor Cosφ	Current		Torque		Moment of inertia J = 1/4 GD ² kgm ²	Weight kg	Sound pressure Level L _{PA} dB	
				Full load 100%	3/4 load 75%	1/2 load 50%		I _N A	I _s /I _N	T _N Nm	T _i /T _N				T _b /T _N
1500 r/min = 4 poles				400 V 50 Hz				High-output							
18.5	M3GP 160MLF 4	3GGP162460---D	1469	91.8	92.2	91.6	0.83	35.0	8.2	120	3.5	3.8	0.13	178	68
22	M3GP 160MLG 4	3GGP162470---D	1466	90.8	91.1	90.3	0.81	43.9	8.6	143	2.9	3.9	0.13	249	68
30	M3GP 180MLC 4	3GGP182430---D	1466	92.1	92.4	91.8	0.81	59.5	7.6	195	2.2	3.3	0.248	298	66
37	M3GP 200MLC 4	3GGP202430---D	1475	93.0	93.1	92.4	0.82	70.5	7.5	239	2.9	3.2	0.34	305	73
55	M3GP 225SMD 4	3GGP222240---D	1483	94.3	94.4	93.9	0.83	101	7.4	354	3.4	2.9	0.55	410	68
75	M3GP 250SMB 4	3GGP252220---D	1476	93.8	94.2	93.9	0.86	135	7.0	485	2.6	2.9	0.88	490	73
110	M3GP 280SMC 4	3GGP282230---G	1485	95.1	95.4	95.1	0.86	193	7.6	707	3.0	3.0	1.85	725	68
132	M3GP 280MLA 4	3GGP282410---G	1483	95.3	95.5	95.1	0.86	232	7.0	849	2.7	2.8	2.3	840	75
160	M3GP 280MLB 4	3GGP282420---G	1484	95.6	95.9	95.7	0.85	284	7.4	1029	2.9	2.9	2.5	890	75

Equipment protection level and equipment group subdivision must be selected when ordering by selecting appropriate variant code:

334 - Ex t, dust group IIIB T125 Db (non-conductive dust) acc. to IEC/EN60079-31

335 - Ex t, dust group IIIB T125 Dc (non-conductive dust) acc. to IEC/EN60079-31

336 - Ex t, dust group IIIC T125 Db (conductive dust) acc. to IEC/EN60079-31

337 - Ex t, dust group IIIC T125 Dc (conductive dust) acc. to IEC/EN60079-31

Technical data for Ex t IIIB/IIIC IE2 cast iron motors, 1000 r/min

IP 55 - IC 411 - Insulation class F, temperature rise class B
IE2 efficiency class according to IEC 60034-30-1; 2014

Output kW	Motor type	Product code	Speed r/min	Efficiency IEC 60034-30-1; 2014			Power factor Cosφ	Current		Torque		Moment of inertia J = 1/4 GD ² kgm ²	Weight kg	Sound pressure Level L _{PA} dB	
				Full load 100%	3/4 load 75%	1/2 load 50%		I _N A	I _s /I _N	T _N Nm	T _i /T _N				T _b /T _N
1000 r/min = 6 poles				400 V 50 Hz				CENELEC							
0.18	M3GP 71MA 6	3GGP073321---B	900	56.6	56.0	49.8	0.73	0.58	3.1	1.91	1.9	1.9	0.0009	10	42
0.25	M3GP 71MB 6	3GGP073322---B	910	61.6	61.0	55.3	0.67	0.85	3.3	2.6	2.4	2.6	0.0011	12	42
0.37	M3GP 80MA 6	3GGP083321---B	923	67.6	67.5	62.6	0.73	1.04	4.4	3.8	2.6	2.8	0.0019	15	47
0.55	M3GP 80MB 6	3GGP083322---B	905	73.1	75.9	75.1	0.76	1.42	4.4	5.8	2.7	2.5	0.0034	20	47
0.75	M3GP 90SLC 6	3GGP093323---B	960	76.3	74.7	69.5	0.58	2.3	4.5	7.4	2.4	3.1	0.00491	25	44
1.1	M3GP 90SLE 6	3GGP093324---B	930	78.2	78.7	76.6	0.66	3.0	4.0	11.2	1.9	2.3	0.0054	28	44
1.5	M3GP 100L 6	3GGP103322---B	950	81.3	82.1	80.7	0.69	3.7	4.3	15.0	1.5	2.7	0.00873	37	49
2.2	M3GP 112MB 6	3GGP113322---B	950	82.5	83.7	81.6	0.71	5.5	4.4	22.1	1.7	2.3	0.0125	44	66
3	M3GP 132SMB 6	3GGP133321---B	975	85.3	84.2	81.2	0.63	8.0	5.5	29.4	1.8	2.9	0.0334	69	57
4	M3GP 132SMC 6	3GGP133322---B	960	84.9	85.4	83.9	0.68	10.0	5.2	39.7	2.0	2.6	0.0334	69	57
5.5	M3GP 132SMF 6	3GGP133324---B	965	86.1	86.6	85.5	0.71	12.9	5.1	54.4	2.0	2.3	0.0487	86	57
7.5	M3GP 160MLA 6	3GGP163410---D	965	87.6	88.6	88.3	0.78	15.8	6.4	74.2	1.7	2.9	0.126	181	65
11	M3GP 160MLB 6	3GGP163420---D	972	90.1	91.0	90.4	0.81	22.1	6.9	108	2.4	3.5	0.126	181	65
15	M3GP 180MLB 6	3GGP183420---D	973	89.7	90.4	89.7	0.82	29.7	6.8	147	1.8	3.0	0.25	240	60
18.5	M3GP 200MLA 6	3GGP203410---D	983	90.5	90.9	90.2	0.82	36.2	6.4	179	2.4	3.1	0.37	266	66
22	M3GP 200MLB 6	3GGP203420---D	983	91.6	92.0	91.5	0.82	42.8	7.5	213	3.2	3.2	0.43	283	61
30	M3GP 225SMB 6	3GGP223220---D	985	92.2	92.7	92.4	0.82	57.9	7.4	290	2.7	3.0	0.64	344	61
37	M3GP 250SMA 6	3GGP253210---D	990	92.2	92.6	92.5	0.81	70.6	6.5	357	2.6	3.1	1.16	440	66
45	M3GP 280SMA 6	3GGP283210---G	990	93.4	93.8	93.5	0.83	83.8	7.0	434	2.5	2.5	1.85	605	66
55	M3GP 280SMB 6	3GGP283220---G	990	93.1	93.6	93.3	0.84	100	7.0	530	2.7	2.6	2.2	645	66
75	M3GP 315SMA 6	3GGP313210---G	992	94.4	94.4	93.5	0.82	139	7.4	721	2.4	2.8	3.2	830	70
90	M3GP 315SMB 6	3GGP313220---G	992	94.8	94.7	94.1	0.84	166	7.5	866	2.4	2.8	4.1	930	70
110	M3GP 315SMC 6	3GGP313230---G	991	95.0	95.0	94.6	0.83	201	7.4	1059	2.5	2.9	4.9	1000	70
132	M3GP 315MLA 6	3GGP313410---G	991	95.3	95.4	94.9	0.83	240	7.5	1271	2.7	3.0	5.8	1150	68
160	M3GP 355SMA 6	3GGP353210---G	993	95.4	95.6	95.2	0.83	291	7.0	1538	2.0	2.6	7.9	1520	75
200	M3GP 355SMB 6	3GGP353220---G	993	95.7	95.9	95.7	0.83	364	7.2	1923	2.6	2.7	9.7	1680	75
250	M3GP 355SMC 6	3GGP353230---G	993	95.7	95.8	95.4	0.82	460	7.4	2404	2.6	2.9	11.3	1820	75
315	M3GP 355MLB 6	3GGP353420---G	992	95.7	96.0	95.5	0.83	570	7.0	3032	2.5	2.7	13.5	2180	75
355	M3GP 355LKA 6	3GGP353810---G	992	95.7	95.9	95.4	0.81	658	7.6	3417	2.7	2.9	15.5	2500	75
450 ³⁾	M3GP 400LB 6	3GGP403520---G	994	95.8	95.8	95.2	0.82	819	7.4	4323	2.4	2.8	20.5	3150	76
450	M3GP 400LKB 6	3GGP403820---G	994	95.8	95.8	95.2	0.82	819	7.4	4323	2.4	2.8	20.5	3150	76
500	M3GP 400LC 6	3GGP403530---G	993	95.8	95.6	95.2	0.83	891	7.2	4809	2.5	2.7	22	3300	76
500 ³⁾	M3GP 400LKC 6	3GGP403830---G	993	95.8	95.6	95.2	0.83	891	7.2	4809	2.5	2.7	22	3300	76
560 ³⁾	M3GP 400LD 6	3GGP403540---G	993	96.6	96.6	96.0	0.85	984	7.4	5386	2.4	2.8	24	3400	77
560	M3GP 400LKD 6	3GGP403840---G	993	96.6	96.6	96.0	0.85	984	7.4	5386	2.4	2.8	24	3400	77
630	M3GP 450LA 6	3GGP453510---G	994	95.8	95.9	95.3	0.84	1127	6.5	6053	1.1	2.5	31	4150	81
710	M3GP 450LB 6	3GGP453520---G	995	96.6	96.7	96.1	0.85	1244	7.0	6814	1.3	2.5	37	4500	81
800	M3GP 450LC 6	3GGP453530---G	995	96.6	96.6	96.0	0.84	1415	7.2	7677	1.3	2.7	41	4800	81

³⁾ For 400-415 V 50 Hz (380 V 50 Hz voltage code B)

Equipment protection level and equipment group subdivision must be selected when ordering by selecting appropriate variant code:

334 - Ex t, dust group IIIB T125 Db (non-conductive dust) acc. to IEC/EN60079-31

335 - Ex t, dust group IIIB T125 Dc (non-conductive dust) acc. to IEC/EN60079-31

336 - Ex t, dust group IIIC T125 Db (conductive dust) acc. to IEC/EN60079-31

337 - Ex t, dust group IIIC T125 Dc (conductive dust) acc. to IEC/EN60079-31

Technical data for Ex t IIIB/IIIC IE2 cast iron motors, 1000 r/min

IP 55 - IC 411 - Insulation class F, temperature rise class B
IE2 efficiency class according to IEC 60034-30-1; 2014

Output kW	Motor type	Product code	Speed r/min	Efficiency IEC 60034-30-1; 2014			Power factor Cosφ	Current		Torque		Moment of inertia J = 1/4 GD ² kgm ²	Weight kg	Sound pressure Level L _{PA} dB	
				Full load 100%	3/4 load 75%	1/2 load 50%		I _N A	I _s /I _N	T _N Nm	T _i /T _N				T _b /T _N
1000 r/min = 6 poles				400 V 50 Hz				High-output							
14	M3GP 160MLC 6	3GGP163430-...D	969	89.2	89.5	88.5	0.75	30.1	7.5	138	2.8	4.0	0.126	181	64
18.5	M3GP 180MLC 6	3GGP183430-...D	971	90.1	90.1	88.5	0.74	41.1	7.3	181	2.5	3.7	0.25	240	61
30	M3GP 200MLC 6	3GGP203430-...D	983	90.6	90.8	89.6	0.81	59.3	7.5	291	3.5	3.4	0.49	302	65
37	M3GP 225SMC 6	3GGP223230-...D	983	91.8	92.2	92.2	0.83	69.6	7.1	359	2.4	2.8	0.75	371	64
45	M3GP 250SMB 6	3GGP253220-...D	986	93.1	93.4	93.2	0.84	84.0	7.2	435	3.3	2.8	1.49	487	65
75	M3GP 280SMC 6	3GGP283230-...G	990	94.2	94.7	94.5	0.84	137	7.3	723	2.8	2.7	2.85	725	66
90	M3GP 280MLA 6	3GGP283410-...G	990	94.1	94.3	93.7	0.81	170	7.1	868	2.4	2.5	3.1	840	70
110	M3GP 280MLB 6	3GGP283420-...G	990	94.5	94.8	94.4	0.82	205	7.5	1061	2.7	2.6	4.1	890	70

Equipment protection level and equipment group subdivision must be selected when ordering by selecting appropriate variant code:

334 - Ex t, dust group IIIB T125 Db (non-conductive dust) acc. to IEC/EN60079-31

335 - Ex t, dust group IIIB T125 Dc (non-conductive dust) acc. to IEC/EN60079-31

336 - Ex t, dust group IIIC T125 Db (conductive dust) acc. to IEC/EN60079-31

337 - Ex t, dust group IIIC T125 Dc (conductive dust) acc. to IEC/EN60079-31

Technical data for Ex t IIIB/IIIC IE2 cast iron motors, 750 r/min

IP 55 - IC 411 - Insulation class F, temperature rise class B
IE2 efficiency class according to IEC 60034-30-1; 2014

Output kW	Motor type	Product code	Speed r/min	Efficiency IEC 60034-30-1; 2014			Power factor Cosφ	Current		Torque		Moment of inertia J = 1/4 GD ² kgm ²	Weight kg	Sound pressure Level L _{PA} dB	
				Full load 100%	3/4 load 75%	1/2 load 50%		I _N A	I _s /I _N	T _N Nm	T _i /T _N				T _b /T _N
750 r/min = 8 poles				400 V 50 Hz				CENELEC							
0.09	M3GP 71MA 8	3GGP074101---B	660	49.4	46.3	39.6	0.60	0.44	2.7	1.30	2.0	2.5	0.00089	11	40
0.12	M3GP 71MB 8	3GGP074102---B	685	39.8	34.2	23.9	0.58	0.60	2.7	1.67	2.1	2.4	0.0011	12	43
0.18	M3GP 80MA 8	3GGP084101---B	680	45.9	45.4	38.6	0.61	0.70	3.0	2.5	2.0	2.4	0.0019	15	45
0.25	M3GP 80MB 8	3GGP084102---B	680	50.6	51.0	46.0	0.62	0.94	3.3	3.5	2.0	2.2	0.0024	17	50
0.37	M3GP 90SLB 8	3GGP094102---B	705	56.1	54.5	47.1	0.57	1.47	2.8	5.0	1.8	2.2	0.0044	24	50
0.55	M3GP 90SLC 8	3GGP094103---B	673	61.7	63.6	59.8	0.61	2.1	2.6	7.8	1.5	1.8	0.0049	25	53
0.75	M3GP 100LA 8	3GGP104101---B	710	74.0	72.3	67.1	0.61	2.5	3.7	10.1	1.8	2.6	0.0072	30	46
1.1	M3GP 100LB 8	3GGP104102---B	695	76.0	76.4	74.5	0.66	3.1	3.6	15.1	1.6	2.3	0.00871	30	53
1.5	M3GP 112M 8	3GGP114101---B	690	74.4	75.9	74.1	0.74	4.1	3.5	20.9	1.9	2.5	0.0106	39	55
2.2	M3GP 132SMA 8	3GGP134101---B	715	79.7	79.5	77.1	0.66	6.5	4.7	29.2	1.6	2.8	0.0334	70	56
3	M3GP 132SMB 8	3GGP134102---B	715	79.9	79.7	76.6	0.64	8.5	4.7	39.7	1.7	2.8	0.04	75	58
4	M3GP 160MLA 8	3GGP164410---D	722	83.3	84.7	84.2	0.70	10.3	4.7	52.9	1.6	2.6	0.133	181	59
5.5	M3GP 160MLB 8	3GGP164420---D	723	86.8	87.2	86.0	0.71	13.5	5.8	72.7	1.9	3.1	0.133	245	53
7.5	M3GP 160MLC 8	3GGP164430---D	718	82.0	84.0	84.0	0.70	19.3	5.7	99.8	2.1	2.9	0.133	245	55
11	M3GP 180MLB 8	3GGP184420---D	723	88.3	89.2	88.7	0.72	25.5	5.6	145	2.0	3.0	0.245	292	63
15	M3GP 200MLA 8	3GGP204410---D	734	89.9	90.4	89.5	0.79	30.6	6.9	195	2.4	3.2	0.45	280	56
18.5	M3GP 225SMA 8	3GGP224210---D	734	90.0	90.7	90.2	0.74	39.2	6.1	240	2.2	3.0	0.61	326	55
22	M3GP 225SMB 8	3GGP224220---D	732	90.6	91.4	91.2	0.81	45.3	6.5	287	1.9	2.9	0.68	343	56
30	M3GP 250SMA 8	3GGP254210---D	735	91.6	91.0	90.5	0.78	60.7	6.7	389	2.0	2.9	1.25	440	56
37	M3GP 280SMA 8	3GGP284210---G	741	91.7	92.0	91.2	0.79	72.6	7.3	476	1.7	3.0	1.85	605	65
45	M3GP 280SMB 8	3GGP284220---G	741	92.1	92.3	91.7	0.78	89.2	7.6	579	1.8	3.1	2.2	645	65
55	M3GP 315SMA 8	3GGP314210---G	742	92.4	93.0	92.4	0.79	106	7.1	707	1.6	2.7	3.2	830	62
75	M3GP 315SMB 8	3GGP314220---G	741	93.0	93.2	93.0	0.82	146	7.1	966	1.7	2.7	4.1	930	62
90	M3GP 315SMC 8	3GGP314230---G	741	93.3	93.7	93.3	0.82	170	7.4	1159	1.8	2.7	4.9	1000	64
110	M3GP 315MLA 8	3GGP314410---G	740	93.6	93.9	94.0	0.83	211	7.3	1419	1.8	2.7	5.8	1150	72
132	M3GP 355SMA 8	3GGP354210---G	744	93.9	93.8	93.3	0.80	256	7.5	1694	1.5	2.6	7.9	1520	69
160	M3GP 355SMB 8	3GGP354220---G	744	94.2	94.2	93.7	0.77	293	7.6	2053	1.6	2.6	9.7	1680	69
200	M3GP 355SMC 8	3GGP354230---G	742	94.5	95.0	94.8	0.79	385	7.4	2576	1.6	2.6	11.3	1820	69
315	³⁾ M3GP 400LA 8	3GGP404510---G	744	96.1	96.0	95.6	0.81	592	7.0	4043	1.2	2.6	17	2900	71
315	M3GP 400LKA 8	3GGP404810---G	744	96.1	96.0	95.6	0.81	592	7.0	4043	1.2	2.6	17	2900	71
355	M3GP 400LB 8	3GGP404520---G	743	95.8	96.0	95.8	0.83	641	6.8	4562	1.2	2.5	21	3200	71
355	³⁾ M3GP 400LKB 8	3GGP404820---G	743	95.8	96.0	95.8	0.83	641	6.8	4562	1.2	2.5	21	3200	71
400	³⁾ M3GP 400LC 8	3GGP404530---G	744	96.0	96.3	95.8	0.82	735	6.0	5134	1.3	2.7	24	3400	71
400	M3GP 400LKC 8	3GGP404830---G	744	96.0	96.3	95.8	0.82	735	6.0	5134	1.3	2.7	24	3400	71
450	M3GP 450LA 8	3GGP454510---G	744	96.2	96.5	96.2	0.83	813	6.0	5775	1.0	2.5	26	3750	80
500	M3GP 450LB 8	3GGP454520---G	744	96.3	96.4	96.2	0.83	902	6.4	6417	1.0	2.6	29	4000	80
560	M3GP 450LC 8	3GGP454530---G	744	96.4	96.5	96.1	0.82	1038	7.0	7188	1.2	2.9	35	4350	80
630	M3GP 450LD 8	3GGP454540---G	745	96.6	96.7	96.2	0.81	1162	7.6	8075	1.3	3.2	41	4800	80

³⁾ For 400-415 V 50 Hz (380 V 50 Hz voltage code B)

Equipment protection level and equipment group subdivision must be selected when ordering by selecting appropriate variant code:

334 - Ex t, dust group IIIB T125 Db (non-conductive dust) acc. to IEC/EN60079-31

335 - Ex t, dust group IIIB T125 Dc (non-conductive dust) acc. to IEC/EN60079-31

336 - Ex t, dust group IIIC T125 Db (conductive dust) acc. to IEC/EN60079-31

337 - Ex t, dust group IIIC T125 Dc (conductive dust) acc. to IEC/EN60079-31

Technical data for Ex t IIIB/IIIC

IE2 cast iron motors, 750 r/min

IP 55 - IC 411 - Insulation class F, temperature rise class B
IE2 efficiency class according to IEC 60034-30-1; 2014

Output kW	Motor type	Product code	Speed r/min	Efficiency IEC 60034-30-1; 2014			Power factor Cosφ	Current		Torque		Moment of inertia J = 1/4 GD ² kgm ²	Weight kg	Sound pressure Level L _{PA} dB	
				Full load 100%	3/4 load 75%	1/2 load 50%		I _N A	I _s /I _N	T _N Nm	T _i /T _N				T _b /T _N
750 r/min = 8 poles				400 V 50 Hz				High-output							
18.5	M3GP 200MLB 8	3GGP204420---D	734	89.2	89.8	88.8	0.80	37.1	6.9	240	2.2	3.2	0.54	300	57
30	M3GP 225SMC 8	3GGP224230---D	731	90.7	91.6	91.6	0.78	61.2	6.3	391	2.3	3.0	0.75	369	59
37	M3GP 250SMB 8	3GGP254220---D	737	92.2	92.9	92.5	0.79	73.0	7.5	479	2.3	3.4	1.52	487	59
55	M3GP 280SMC 8	3GGP284230---G	741	92.4	92.8	92.7	0.80	107	7.9	708	1.9	3.1	2.85	725	65
75	M3GP 280MLB 8	3GGP284420---G	739	93.7	93.9	93.3	0.80	144	6.7	969	1.7	2.6	4.1	890	72

Equipment protection level and equipment group subdivision must be selected when ordering by selecting appropriate variant code:

334 - Ex t, dust group IIIB T125 Db (non-conductive dust) acc. to IEC/EN60079-31

335 - Ex t, dust group IIIB T125 Dc (non-conductive dust) acc. to IEC/EN60079-31

336 - Ex t, dust group IIIC T125 Db (conductive dust) acc. to IEC/EN60079-31

337 - Ex t, dust group IIIC T125 Dc (conductive dust) acc. to IEC/EN60079-31

Variant codes

Dust ignition protection cast iron motors

Variant codes specify additional options and features to the standard motor. The desired features are listed as three-digit variant codes in the motor order. Note also that there are variants that cannot be used together.

Most of the variant codes apply to IE2 and IE3 motors. However, confirm the availability of variants for IE motors with your ABB sales office before making an order.

		Frame size															
Code/Variant, M3GP		71	80	90	100	112	132	160	180	200	225	250	280	315	355	400	450
Administration																	
529	Customer witnessed visual inspection of complete order line.	●	●	●	●	●	●	●	●	●	●	●	●	●	●	●	●
530	Two-year extension on standard warranty	●	●	●	●	●	●	●	●	●	●	●	●	●	●	●	●
531	Sea freight packing	●	●	●	●	●	●	●	●	●	●	●	●	●	●	●	●
533	Wooden sea freight packing	-	-	-	-	-	-	-	-	-	-	-	●	●	●	●	●
590	Mounting of customer supplied part other than coupling.	●	●	●	●	●	●	●	●	●	●	●	●	●	●	●	●
648	Rating plate in special language	●	●	●	●	●	●	●	●	●	●	●	●	●	●	●	●
Balancing																	
417	Vibration acc. to Grade B (IEC 60034-14).	●	●	●	●	●	●	●	●	●	●	●	●	●	●	●	●
423	Balanced without key.	●	●	●	●	●	●	●	●	●	●	●	●	●	●	●	●
424	Full-key balancing	●	●	●	●	●	●	●	●	●	●	●	●	●	●	●	●
Bearings and Lubrication																	
036	Transport lock for bearings.	-	-	-	-	-	-	●	●	●	●	●	●	●	●	●	●
037	Roller bearing at D-end.	●	●	●	●	●	●	●	●	●	●	●	●	●	●	●	●
040	Heat-resistant grease	○	○	○	○	○	○	●	●	●	●	●	●	●	●	●	●
043	SPM compatible nipples for vibration measurement	●	●	●	●	●	●	○	○	○	○	○	○	○	○	-	-
058	Angular contact bearing at D-end, shaft force away from bearing.	-	-	-	-	-	-	●	●	●	●	●	●	●	●	●	●
059	Angular contact bearing at N-end, shaft force towards bearing.	-	-	-	-	-	-	-	-	●	●	●	●	●	●	●	●
060	Angular contact bearing at D-end, shaft force towards bearing.	-	-	-	-	-	-	-	-	-	-	-	●	●	●	●	●
061	Angular contact bearing at N-end, shaft force away from bearing.	-	-	-	-	-	-	-	-	-	-	-	●	●	●	●	●
107	Pt100 2-wire in bearings.	-	-	-	-	-	-	●	●	●	●	●	●	●	●	●	●
128	Double PT100, 2-wire in bearings	-	-	-	-	-	-	●	●	●	●	●	●	●	●	●	●
129	Double PT100, 3-wire in bearings	-	-	-	-	-	-	●	●	●	●	●	●	●	●	●	●
130	Pt100 3-wire in bearings.	-	-	-	-	-	-	●	●	●	●	●	●	●	●	●	●
188	63-series bearing in D-end	●	●	●	●	●	●	-	-	-	-	-	-	-	-	-	-
194	2Z bearings greased for life at both ends.	○	○	○	○	○	○	●	●	●	●	●	●	-	-	-	-
433	Outlet grease collector	-	-	-	-	-	-	-	-	-	-	-	●	●	●	●	●
506	Nipples for vibration measurement : SKF Marlin Quick Connect stud CMSS-2600-3	-	-	-	-	-	-	●	●	●	●	●	●	●	●	-	-
593	Bearings grease suitable for food and beverage industry.	●	●	●	●	●	●	●	●	●	●	●	●	●	●	●	●
654	Provision for vibration sensors (M8x1)	-	-	-	-	-	-	●	●	●	●	●	●	●	●	●	●
795	Lubrication information plate	-	-	-	-	-	-	●	●	●	●	●	○	○	○	-	-
796	Grease nipples JIS B 1575 PT 1/8 Type A	-	-	-	-	-	-	●	●	●	●	●	●	●	●	●	●
797	Stainless steel SPM nipples	●	●	●	●	●	●	●	●	●	●	●	●	●	●	●	●
798	Stainless steel grease nipples	-	-	-	-	-	-	●	●	●	●	●	●	●	●	●	●
799	Grease nipples flat type DIN 3404, thread M10x1	-	-	-	-	-	-	●	●	●	●	●	●	●	●	●	●
800	Grease nipples JIS B 1575 PT 1/8" pin type	-	-	-	-	-	-	●	●	●	●	●	●	●	●	●	●
Branch standard designs																	
178	Stainless steel / acid proof bolts.	○	○	○	○	○	○	●	●	●	●	●	●	●	●	●	●
204	Jacking bolts for foot mounted motors.	-	-	-	-	-	-	●	●	●	●	●	●	●	○	-	-
209	Non-standard voltage or frequency, (special winding).	●	●	●	●	●	●	●	●	●	●	●	●	●	●	●	●
396	Motor designed for minimum ambient temperature -20 °C to -40 °C, with space heaters (code 450/451 must be added)	●	●	●	●	●	●	●	●	●	●	●	●	●	●	●	●
397	Motor designed for minimum ambient temperature -40 °C to -55 °C, - with space heaters (code 450/451 must be added)	-	-	-	-	-	-	●	●	●	●	●	●	●	●	●	●
398	Motor designed for minimum ambient temperature -20 °C to -40 °C	●	●	●	●	●	●	●	●	●	●	●	●	●	●	●	●
399	Motor designed for minimum ambient temperature -40 °C to -55 °C	-	-	-	-	-	-	●	●	●	●	●	●	●	●	●	●
425	Corrosion protected stator and rotor core.	●	●	●	●	●	●	●	●	●	●	●	●	●	●	●	●

○ = Included as standard | ● = Available as option | - = Not applicable

Code/Variant, M3GP	Frame size															
	71	80	90	100	112	132	160	180	200	225	250	280	315	355	400	450
524	Special run-out tolerances on flange and shaft for close coupled pump applications.	-	-	-	-	-	-	•	•	•	•	•	•	•	-	-
786	Special design shaft upwards (V3, V36, V6) for outdoor mounting.	-	•	•	•	-	•	•	•	•	•	-	-	-	-	-
Cooling system																
044	Unidirectional fan for reduced noise level. Rotation clockwise seen from D-end. Available only for 2-pole motors.	-	-	-	-	-	-	-	-	-	-	-	•	•	•	-
045	Unidirectional fan for reduced noise level. Rotation counter clockwise seen from D-end. Available only for 2-pole motors.	-	-	-	-	-	-	-	-	-	-	-	•	•	•	-
068	Light alloy metal fan	•	•	•	•	•	•	•	•	•	•	•	•	•	•	•
183	Separate motor cooling (fan axial, N-end).	-	-	-	-	-	-	•	•	•	•	•	•	•	•	•
206	Steel fan	•	•	•	•	•	•	•	•	•	•	•	•	•	•	-
514	Separate motor cooling (fan on top)	-	-	-	-	-	-	-	-	-	-	-	-	-	•	•
791	Stainless steel fan cover	-	-	-	-	-	-	-	-	-	•	•	•	•	•	•
Coupling																
035	Assembly of customer supplied coupling-half.	-	-	-	-	-	-	-	-	-	-	-	•	•	•	•
Documentation																
141	Binding 2D main dimension drawing.	•	•	•	•	•	•	•	•	•	•	•	•	•	•	•
370	Motor model drawing in 3D	-	•	•	•	•	•	•	•	•	•	•	•	•	•	•
374	Binding 2D motor detailed drawing	•	•	•	•	•	•	•	•	•	•	•	•	•	•	•
536	Photos of manufactured motors	•	•	•	•	•	•	•	•	•	•	•	•	•	•	•
537	Advanced data sheet	•	•	•	•	•	•	•	•	•	•	•	•	•	•	•
722	Rotor dimension drawing (incl. torsional stiffness).	•	•	•	•	•	•	•	•	•	•	•	•	•	•	•
777	Premium documentation package	•	•	•	•	•	•	•	•	•	•	•	•	•	•	•
Drain holes																
065	Plugged existing drain holes.	•	•	•	•	•	•	•	•	•	•	•	•	•	•	•
448	Draining holes with metal plugs.	-	-	-	-	-	-	•	•	•	•	•	•	•	•	•
Earthing Bolt																
525	External earthing bolts on motor feet	-	•	•	•	•	•	•	•	•	•	•	•	•	•	•
Hazardous Environments																
338	Rated for gas or dust, Ex ec IIC T3 Gc / Ex tc IIIB T125C Dc (non-conductive dust), IP5X.	•	•	•	•	•	•	•	•	•	•	•	•	•	•	•
339	Rated for gas or dust, Ex ec IIC T3 Gc / Ex tc IIIC T125C Dc (conductive dust), IP6X.	•	•	•	•	•	•	•	•	•	•	•	•	•	•	•
516	Temperature detectors approved to be connected to an Ex i circuit	-	-	-	-	-	-	•	•	•	•	•	•	•	•	•
807	UL certified Class 1, Div.2 Group A, B, C and D, T3.	•	•	•	•	•	•	•	•	•	•	•	•	•	•	•
813	Thermistor-based surface temperature protection T4 for frequency converter duty.	•	•	•	•	•	•	•	•	•	•	•	•	•	•	•
814	Ex t (DIP) motors, temperature class T 150C.	•	•	•	•	•	•	•	•	•	•	•	•	•	•	•
Heating elements																
450	Heating element, 100-120 V	•	•	•	•	•	•	•	•	•	•	•	•	•	•	•
451	Heating element, 200 - 240 V	•	•	•	•	•	•	•	•	•	•	•	•	•	•	•
Insulation system																
014	Winding insulation class H.	•	•	•	•	•	•	•	•	•	•	•	•	•	•	•
405	Special winding insulation for frequency converter supply.	-	-	•	•	•	•	•	•	•	•	•	•	•	•	•
Marine																
024	Fulfilling Bureau Veritas (BV) requirements, with certificate.	•	•	•	•	•	•	•	•	•	•	•	•	•	•	•
026	Fulfilling Lloyds Register of Shipping (LR) requirements, with certificate.	•	•	•	•	•	•	•	•	•	•	•	•	•	•	•
027	Fulfilling American Bureau of Shipping (ABS) requirements, with certificate.	•	•	•	•	•	•	•	•	•	•	•	•	•	•	•
050	Fulfilling Registro Italiano Navale (RINA) requirements, with certificate.	•	•	•	•	•	•	•	•	-	-	-	-	-	-	•
051	Fulfilling Russian Maritime Register of Shipping (RS) requirements, with certificate.	•	•	•	•	•	•	•	•	-	-	-	-	-	-	•
096	Fulfilling Lloyds Register of Shipping (LR) requirements, without certificate (non-essential duty only)	•	•	•	•	•	•	•	•	•	•	•	•	•	•	•
481	Fulfilling Nippon Kaiji Kyokai (NK) requirements, with certificate.	•	•	•	•	•	•	•	•	-	-	-	-	-	-	•
483	Fulfilling China Classification Societies (CCS) requirements (Beijing), with certificate.	•	•	•	•	•	•	-	-	-	-	-	-	-	-	•
484	Fulfilling Korea Register of Shipping (KR) requirements, with certificate.	•	•	•	•	•	•	•	•	•	•	•	•	•	•	•
491	Fulfilling Nippon Kaiji Kyokai (NK) requirements, without certificate.	•	•	•	•	•	•	•	•	-	-	-	-	-	-	•
492	Fulfilling Registro Italiano Navale (RINA) requirements, without certificate.	•	•	•	•	•	•	•	•	-	-	-	-	-	-	•

○ = Included as standard | ● = Available as option | - = Not applicable

		Frame size															
Code/Variant, M3GP		71	80	90	100	112	132	160	180	200	225	250	280	315	355	400	450
493	Fulfilling China Classification Societies (CCS) requirements (Beijing), without certificate.	•	•	•	•	•	•	•	•	-	-	-	-	-	-	•	•
494	Fulfilling Korea Register of Shipping (KR) requirements, without certificate.	•	•	•	•	•	•	•	•	-	-	-	-	-	-	•	•
496	Fulfilling Bureau Veritas (BV) requirements, without certificate(non-essential duty only)	•	•	•	•	•	•	•	•	•	•	•	•	•	•	•	•
675	Fulfilling American Bureau of Shipping (ABS) requirements, without certificate (non-essential duty only)	•	•	•	•	•	•	•	•	•	•	•	•	•	•	•	•
Mounting arrangements																	
008	IM 2101 foot/flange mounted, IEC flange, from IM 1001 (B34 from B3).	•	•	•	•	•	•	-	-	-	-	-	-	-	-	-	-
009	IM 2001 foot/flange mounted, IEC flange, from IM 1001 (B35 from B3).	•	•	•	•	•	•	•	•	•	•	•	•	•	•	•	•
047	IM 3601 flange mounted, IEC flange, from IM 3001 (B14 from B5).	•	•	•	•	•	•	-	-	-	-	-	-	-	-	-	-
066	Modified for specified mounting position differing from IM B3 (1001), IM B5 (3001), B14 (3601), IM B35 (2001), IM B34 (2101)	•	•	•	•	•	•	•	•	•	•	•	•	•	•	•	•
305	Additional lifting lugs.	-	-	-	-	-	-	-	-	-	-	-	•	•	•	•	•
Painting																	
105	Paint thickness report.	•	•	•	•	•	•	•	•	•	•	•	•	•	•	•	•
114	Special paint color, standard grade	•	•	•	•	•	•	•	•	•	•	•	•	•	•	•	•
115	Painting system C4M acc. to ISO 12944-2: 2007.	•	•	•	•	•	•	•	•	•	•	•	•	•	•	•	•
168	Primer paint only.	•	•	•	•	•	•	•	•	•	•	•	•	•	•	•	•
303	Painted insulation layer on inside of the terminal boxes.	-	-	-	-	-	-	•	•	•	•	•	•	•	•	•	•
710	Thermally sprayed zink metallizing with acrylic top coat	•	•	•	•	•	•	•	•	•	•	•	•	•	•	•	•
711	Painting system C5-M very high, acc. to ISO 12944-5:2007	•	•	•	•	•	•	•	•	•	•	•	•	•	•	•	•
754	Painting system C5M acc. to ISO 12944-2:1998	•	•	•	•	•	•	•	•	•	•	•	•	•	•	•	•
755	Norsok M-501 revision 6, Coating system no. 1	-	-	-	-	-	-	•	•	•	•	•	•	•	•	•	•
Protection																	
005	Protective roof	•	•	•	•	•	•	•	•	•	•	•	•	•	•	•	•
072	Radial seal at D-end. Not possible for 2-pole , 280 and 315 frames	•	•	•	•	•	•	•	•	•	•	•	-	-	-	-	-
073	Sealed against oil at D-end.	-	-	-	-	-	-	-	-	•	•	•	•	•	-	-	-
158	Degree of protection IP65.	•	•	•	•	•	•	•	•	•	•	•	•	•	•	•	•
250	Degree of protection IP66	•	•	•	•	•	•	•	•	•	•	•	•	•	•	•	•
401	Protective roof, horizontal motor.	-	-	-	-	-	-	-	-	-	-	-	•	•	•	•	•
403	Degree of protection IP56.	•	•	•	•	•	•	•	•	•	•	•	•	•	•	•	•
434	Degree of protection IP56, open deck.	-	-	-	-	-	-	-	-	-	-	-	•	•	•	•	•
783	Labyrinth sealing at D-end.	•	•	•	•	•	•	•	•	•	•	•	•	•	•	-	-
Rating & instruction plates																	
002	Restamping voltage, frequency and output, continuous duty.	•	•	•	•	•	•	•	•	•	•	•	•	•	•	•	•
004	Additional text on std rating plate (max 12 digits on free text line).	•	•	•	•	•	•	•	•	•	•	•	•	•	•	•	•
095	Restamping output (maintained voltage, frequency), intermittent duty.	•	•	•	•	•	•	•	•	•	•	•	•	•	•	•	•
126	Tag plate	•	•	•	•	•	•	•	•	•	•	•	•	•	•	•	•
135	Mounting of additional identification plate, stainless.	•	•	•	•	•	•	•	•	•	•	•	•	•	•	•	•
139	Additional identification plate delivered loose.	•	•	•	•	•	•	•	•	•	•	•	•	•	•	•	•
159	Additional plate with text "Made in"	•	•	•	•	•	•	•	•	•	•	•	•	•	•	•	•
161	Additional rating plate delivered loose.	•	•	•	•	•	•	•	•	•	•	•	•	•	•	•	•
163	Frequency converter rating plate. Rating data according to quotation.	•	•	•	•	•	•	•	•	•	•	•	•	•	•	•	•
181	Rating plate with ABB standard loadability values for VSD operation. Other auxiliaries for VSD operation to be selected as necessary.	-	•	•	•	•	•	•	•	•	•	•	•	•	•	•	•
332	Baldor Catalogue #	•	•	•	•	•	•	•	•	•	•	•	•	•	•	•	•
333	Not for use in the USA	•	•	•	•	•	•	•	•	•	•	•	•	•	•	•	•
528	Rating plate sticker	•	•	•	•	•	•	•	•	•	•	•	•	•	•	•	•
Shaft & rotor																	
069	Two shaft extensions according to catalog drawings.	•	•	•	•	•	•	•	•	•	•	•	•	•	•	•	•
070	Special shaft extension at D-End, standard shaft material	•	•	•	•	•	•	•	•	•	•	•	•	•	•	•	•
155	Cylindrical shaft extension, D-end, without key-way.	-	-	-	-	-	-	-	-	•	•	•	•	•	•	•	•
164	Shaft extension with closed keyway	○	○	○	○	○	○	○	○	○	○	○	•	•	•	•	•
165	Shaft extension with open keyway	•	•	•	•	•	•	•	•	•	•	•	○	○	○	-	-
410	Shaft material stainless steel	•	•	•	•	•	•	•	•	•	•	•	•	•	•	•	•
591	Special shaft extension according to customer specification.	•	•	•	•	•	•	•	•	•	•	•	•	•	•	•	•
600	Special shaft extension at N-end, standard shaft material.	•	•	•	•	•	•	•	•	•	•	•	•	•	•	•	•

○ = Included as standard | • = Available as option | - = Not applicable

		Frame size															
Code/Variant, M3GP		71	80	90	100	112	132	160	180	200	225	250	280	315	355	400	450
630	Shaft material certificate 3.1/3.2 according to EN10204:2004	-	-	-	-	-	-	•	•	•	•	•	•	•	•	•	•
Standards and Regulations																	
331	Motor not for sale for use in EU	•	•	•	•	•	•	•	•	•	•	•	•	•	•	•	•
381	Frame agreement betw. ABB and Shell according to Shell DEP 33.66.05.31-GEN February 2018	•	-	-	-	-	-	-	-	-	-	-	-	-	-	•	•
421	VIK design (Verband der Industriellen Energie- und Kraftwirtschaft e.V.).	•	•	•	•	•	•	•	•	•	•	•	•	•	•	•	-
509	Fulfilling US Integral Horsepower Motor Rule (IHP).	-	•	•	•	•	•	•	•	•	•	•	•	•	•	-	-
523	Neste Rotterdam design.	•	•	•	•	•	•	•	•	•	•	•	•	•	•	•	•
540	China energy label	-	•	•	•	•	•	•	•	•	•	•	•	•	•	-	-
541	Inmetro certification	•	•	•	•	•	•	•	•	•	•	•	•	•	•	•	•
543	Australian MEPS	-	-	-	-	-	-	•	•	•	•	•	•	•	•	-	-
544	Australian HE MEPS	-	•	•	•	•	•	•	•	•	•	•	•	•	•	-	-
547	Certificate of conformity according TR-CU 012/2011 for customs union RU, KZ, BY, AM, KG.	•	•	•	•	•	•	•	•	•	•	•	•	•	•	•	•
551	IA certificate of conformity for South Africa	•	•	•	•	•	•	•	•	•	•	•	•	•	•	•	•
558	Saudi Arabian MEPS (SASO)	•	•	•	•	•	•	•	•	•	•	•	•	•	•	•	•
682	CCC Ex certificate for China	•	•	•	•	•	•	•	•	•	•	•	•	•	•	-	-
803	PESO/CCoE certificate for India	•	•	•	•	•	•	•	•	•	•	•	•	•	•	•	•
Stator winding temperature sensors																	
328	PTC - thermistors (3 in series), 120°C, in stator winding	-	-	-	-	-	-	•	•	•	•	•	•	•	•	•	•
435	PTC - thermistors (3 in series), 130 °C, in stator winding	•	•	•	•	•	•	•	•	•	•	•	•	•	•	•	•
439	PTC - thermistors (2x3 in series), 150 °C, in stator winding	•	•	•	•	•	•	•	•	•	•	•	•	•	•	•	•
441	PTC - thermistors (3 in series, 130 °C & 3 in series, 150 °C), in stator winding	•	•	•	•	•	•	•	•	•	•	•	•	•	•	•	•
445	Pt100 2-wire in stator winding, 1 per phase	-	-	-	-	-	-	•	•	•	•	•	•	•	•	•	•
446	Pt100 2-wire in stator winding, 2 per phase	-	-	-	-	-	-	•	•	•	•	•	•	•	•	•	•
502	Pt100 3-wire in stator winding, 1 per phase	-	-	-	-	-	-	•	•	•	•	•	•	•	•	•	•
503	Pt100 3-wire in stator winding, 2 per phase	-	-	-	-	-	-	•	•	•	•	•	•	•	•	•	•
511	PTC thermistors (2 x 3 in series), 130 °C, in stator winding	•	•	•	•	•	•	•	•	•	•	•	•	•	•	•	•
Terminal box																	
019	Larger than standard terminal box.	•	•	•	•	•	•	-	-	-	-	-	•	•	•	•	-
021	Terminal box LHS (seen from D-end).	-	-	-	-	-	-	•	•	•	•	•	•	•	•	-	-
022	Cable entry LHS (seen from D-end).	•	•	•	•	•	•	•	•	•	•	•	•	•	•	•	•
157	Terminal box degree of protection IP65.	•	•	•	•	•	•	•	•	•	•	•	•	•	•	•	•
180	Terminal box RHS (seen from D-end).	-	-	-	-	-	-	•	•	•	•	•	•	•	•	•	-
230	Standard metal cable gland.	•	•	•	•	•	•	•	•	•	•	•	•	•	•	-	-
277	Cable sealing end unit, size small for C-opening	-	-	-	-	-	-	-	-	-	-	-	•	-	-	-	-
278	Cable sealing end unit, size medium for D-opening	-	-	-	-	-	-	-	-	-	-	-	-	•	•	•	•
279	Cable sealing end unit, size large for D-opening	-	-	-	-	-	-	-	-	-	-	-	-	•	•	•	•
292	Adapter C-C	-	-	-	-	-	-	-	-	-	-	-	•	-	-	-	-
293	Adapter D-D	-	-	-	-	-	-	-	-	-	-	-	-	•	•	-	-
294	Adapter E-D	-	-	-	-	-	-	-	-	-	-	-	-	•	•	•	•
295	Adapter E-2D	-	-	-	-	-	-	-	-	-	-	-	-	•	•	-	-
296	Adapter E-3D	-	-	-	-	-	-	-	-	-	-	-	-	-	-	-	•
351	Terminal block turned according to cable entry	-	-	-	-	-	-	-	-	-	-	-	•	•	-	•	•
380	Separate terminal box for temperature detectors, std. material	-	-	-	-	-	-	•	•	•	•	•	•	•	•	•	•
400	4 x 90 degr turnable terminal box.	•	•	•	•	•	•	○	○	○	○	○	○	○	○	-	-
413	Extended cable connection, no terminal box.	-	-	-	-	-	-	•	•	•	•	•	•	•	•	•	-
418	Separate terminal box for auxiliaries, standard material.	-	-	-	-	-	-	•	•	•	•	•	•	•	•	•	•
466	Terminal box at N-end.	-	-	-	-	-	-	•	•	•	•	•	•	•	•	•	•
468	Cable entry from D-end.	•	•	•	•	•	•	•	•	•	•	•	•	•	•	•	-
469	Cable entry from N-end.	•	•	•	•	•	•	•	•	•	•	•	•	•	•	•	-
526	Existing cable entries plugged	○	○	○	○	○	○	○	○	○	○	○	○	○	○	-	-
553	Terminal box degree of protection IP66.	•	•	•	•	•	•	•	•	•	•	•	•	•	•	-	-
554	Cast iron flange for cable glands drilled and tapped according to order.	-	-	-	-	-	-	•	•	•	•	•	•	•	•	•	•
557	Nickel plated cable glands mounted according to order.	•	•	•	•	•	•	•	•	•	•	•	•	•	•	•	•
565	Adapter for terminal box on the side (RHS)	-	-	-	-	-	-	-	-	-	•	•	•	•	•	-	-
566	Adapter for terminal box on the side (LHS)	-	-	-	-	-	-	-	-	-	•	•	•	•	•	-	-
567	Separate terminal box material: cast Iron	-	-	-	-	-	-	○	○	○	○	○	•	•	•	•	•
568	Separate terminal box for heating elements, std. material	-	-	-	-	-	-	•	•	•	•	•	•	•	•	•	•
624	Prepared for inch cable glands according to BSPP standard.	-	-	-	-	-	-	•	•	•	•	•	•	•	•	•	-

○ = Included as standard | • = Available as option | - = Not applicable

		Frame size															
Code/Variant, M3GP		71	80	90	100	112	132	160	180	200	225	250	280	315	355	400	450
727	Stainless steel flange for cable glands drilled and tapped according to order.	-	-	-	-	-	-	•	•	•	•	•	•	•	•	•	•
730	Prepared for NPT cable glands.	•	•	•	•	•	•	•	•	•	•	•	•	•	•	•	•
731	Two standard metal cable glands.	•	•	•	•	•	•	•	•	•	•	•	•	•	•	•	•
734	Standard cable gland, Ex d IIC, armoured cable.	-	-	-	-	-	-	•	•	•	•	•	•	•	•	•	•
735	Standard cable gland, Ex d IIC, non-armoured cable.	-	-	-	-	-	-	•	•	•	•	•	•	•	•	•	•
741	Motor equipped with Ex e terminal box (IEC/EN 60079-7).	-	-	-	-	-	-	•	•	•	•	•	•	•	•	•	•
743	Non-drilled cast iron flange for cable glands	-	-	-	-	-	-	•	•	•	•	•	•	•	•	•	•
744	Stainless steel non-drilled flange for cable glands.	-	-	-	-	-	-	•	•	•	•	•	•	•	•	•	•
Testing																	
145	Type test report from a catalogue motor, 400V 50Hz.	•	•	•	•	•	•	•	•	•	•	•	•	•	•	•	•
146	Type test with report for one motor from specific delivery batch.	•	•	•	•	•	•	•	•	•	•	•	•	•	•	•	•
148	Routine test report.	•	•	•	•	•	•	•	•	•	•	•	•	•	•	•	•
150	Customer witnessed testing. Specify test procedure with other codes.	•	•	•	•	•	•	•	•	•	•	•	•	•	•	•	•
222	Torque/speed test, type test and multi-point load test with report for one motor from specific delivery batch.	•	•	•	•	•	•	•	•	•	•	•	•	•	•	•	•
560	Shaft voltage test, for one motor from specific delivery batch.	-	•	•	•	•	•	•	•	•	•	•	•	•	•	•	•
561	Overspeed test, for one motor from specific delivery batch	•	•	•	•	•	•	•	•	•	•	•	•	•	•	•	•
562	Overvoltage test, for one motor from specific delivery batch.	-	•	•	•	•	•	•	•	•	•	•	•	•	•	•	•
760	Vibration level test	•	•	•	•	•	•	•	•	•	•	•	•	•	•	•	•
761	Vibration spectrum test for one motor from specific delivery batch.	•	•	•	•	•	•	•	•	•	•	•	•	•	•	•	•
762	Noise level test for one motor from specific delivery batch.	•	•	•	•	•	•	•	•	•	•	•	•	•	•	•	•
763	Noise spectrum test for one motor from specific delivery batch.	-	-	-	-	-	-	•	•	•	•	•	•	•	•	•	•
764	Test for one motor from specific delivery batch with ABB frequency converter available at ABB test field. ABB standard test procedure.	•	•	•	•	•	•	•	•	•	•	•	•	•	•	•	•
Variable speed drives																	
182	Mounting of non-listed pulse tacho.	-	-	-	-	-	-	•	•	•	•	•	•	•	•	•	•
470	Prepared for hollow shaft pulse tacho (L&L equivalent).	-	-	-	-	-	-	•	•	•	•	•	•	•	•	•	•
479	Mounting of other type of pulse tacho with shaft extension, tacho not included.	-	-	-	-	-	-	•	•	•	•	•	•	•	•	•	•
680	2048 pulse tacho, Ex d, tD, L&L 841910001	-	-	-	-	-	-	•	•	•	•	•	•	•	•	•	•
701	Insulated bearing at N-end.	-	-	-	-	-	-	-	-	-	-	-	•	•	•	•	•
704	EMC cable entry.	•	•	•	•	•	•	•	•	•	•	•	•	•	•	•	•
747	1024 pulse tacho, Ex d, tD, L&L 841910002	-	-	-	-	-	-	•	•	•	•	•	•	•	•	•	•

○ = Included as standard | ● = Available as option | - = Not applicable

Mechanical design

Motor frame and drain holes

Motor frame

The motor frame, end shields and main terminal box are made of cast iron. Feet are integrated with the frame, except for sizes 160-250 with side mounted terminal box, which have detachable feet.

Motors can be supplied for foot mounting, flange mounting, and combinations of these.

Drain holes

Dust ignition protection motors are provided with drain holes fitted with plugs as standard. The plugs are made of plastic material and delivered in closed position.

When mounting arrangement differs from foot mounted IM B3, mention variant code 066 when ordering to ensure the drain plug is mounted in the lowest position.

Lifting lugs

The motors are provided as standard with lifting lugs according to the table below. For improved lifting possibilities can variant code 305 be added, please refer to the variant code section for information about availability.

Frame size	Type of lugs	Foot mounted motors	Flange mounted motors
71, 80	No lugs, weight of motors is less than 25 kg	-	-
90-132	Detachable eye bolt	2 pcs on top of motor diagonally placed, size M8	2 pcs on top of motor diagonally placed, size M8
160-200	Integrated in casting / detachable eye bolt	2 pcs on top of motor diagonally placed, integrated in frame casting	Locations for eye bolts: 4 pcs at N-end and 4 pcs at D-end. 2 pcs eye bolts size M12 delivered with each motor
225-250	Integrated in casting / detachable eye bolt	2 pcs on top of motor diagonally placed, integrated in frame casting	Locations for eye bolts: 4 pcs at N-end and 4 pcs at D-end. 2 pcs eye bolts size M16 delivered with each motor
280, 315	Detachable eye bolt	1 pcs close to terminal box on top, size M24	Locations for eye bolts: 4 pcs at N-end and 4 pcs at D-end, one location on top close to terminal box. 2 pcs eye bolts size M24 delivered with each motor
355	Detachable eye bolt	1 pcs close to terminal box on top, size M30	Locations for eye bolts: 4 pcs at N-end and 4 pcs at D-end, one location on top close to terminal box. 2 pcs eye bolts size M30 delivered with each motor
400	Detachable eye bolt	1 pcs close to terminal box on top, size M36	Locations for eye bolts: 4 pcs at N-end and 4 pcs at D-end, one location on top close to terminal box. 2 pcs eye bolts size M36 delivered with each motor
450	Detachable eye bolt	Locations for eye bolts: 4 pcs at N-end and 4 pcs at D-end, one location on top close to terminal box. 3 pcs eye bolts size M42 delivered with each motor	Locations for eye bolts: 4 pcs at N-end and 4 pcs at D-end, one location on top close to terminal box. 2 pcs eye bolts size M42 delivered with each motor

Mechanical design

Heating elements

Heating elements are installed on stator winding coil heads to keep the winding free of corrosion in humid conditions. The power of the heating elements is shown in the table. You can order heating elements with variant code 450 or 451.

Motor size	71	80	90	100	112	132	160	180
Power (W)	25	25	25	25	25	25	25	25

Motor size	200	225	250	280	315	355	400	450
Power (W)	25	60	60	60	2x60	2x60	2x60	2x100

Motors for marine applications mounted on open deck may have heating element powers differing from the ones shown in this table.

Mechanical design

Bearings

ABB's dust ignition protection motors are normally fitted with single-row deep-groove grease lubricated ball bearings, as shown in the table below.

If the bearing at the D-end is replaced with a roller bearing (NU- or NJ-), higher radial forces can be handled. Roller bearings are suitable for belt-drive applications and can be ordered with variant code 037.

When high axial forces are involved, angular-contact ball bearings should be used. When ordering a motor with an angular-contact ball bearing, specify also the method of mounting and the direction and magnitude of axial force to ensure that optimal bearing system design is chosen. The variant codes for ordering angular-contact ball bearings at D-end are 058 and 060.

Standard and alternative designs

Motor size	Number of poles	Standard design		Alternative design D-end	
		Deep groove ball bearings		Roller bearings (037)	Angular contact ball bearing (058, 060)
		D-end	N-end		
71	2 - 8	6203-2Z/C3	6202-2Z/C3	NA	NA
80	2 - 8	6204-2Z/C3	6203-2Z/C3	NA	NA
90	2 - 8	6205-2Z/C3	6204-2Z/C3	NA	NA
100	2 - 8	6206-2Z/C3	6205-2Z/C3	NA	NA
112	2 - 8	6206-2Z/C3	6205-2Z/C3 ¹⁾	NA	NA
132	2 - 8	6208-2Z/C3	6208-2Z/C3	NA	NA
160	2 - 12	6309/C3	6209/C3	NU 309 ECP/C3	7309 B
180	2 - 12	6310/C3	6209/C3	NU 310 ECP/C3	7310 B
200	4 - 12	6312/C3	6210/C3	NU 312 ECP/C3	7312 B
225	4 - 12	6313/C3	6212/C3	NU 313 ECP/C3	7313 B
250	4 - 12	6315/C3	6213/C3	NU 315 ECP/C3	7315 B
280	2	6316/C3	6316/C3	²⁾	7316 B
	4 - 12	6316/C3	6316/C3	NU 316 ECP/C3	7316 B
315	2	6316/C3	6316/C3	²⁾	7316 B
	4 - 12	6319/C3	6316/C3	NU 319 ECP/C3	7319 B
355	2	6316M/C3	6316M/C3	²⁾	7316 B
	4 - 12	6322/C3	6316/C3	NU 322 ECP/C3	7322 B
400	2	6317M/C3	6317M/C3	²⁾	7317 B
	4 - 12	6324/C3	6319/C3	NU 324 ECP/C3	7324 B
450	2	6317M/C3	6317M/C3	²⁾	7317 B
	4 - 12	6326M/C3	6322/C3	NU 326 ECP/C3	7326 B

¹⁾ N-end bearing 6206-2Z/C3 on IE3 motors

²⁾ On request

Axially-locked bearings

All motors with deep groove ball bearings are equipped as standard with an axially locked bearing at the D-end.

Transport locking

Motors with roller bearings or an angular-contact ball bearing are fitted with a transport lock before dispatch to prevent damage to bearings during transport. A warning label is attached to motors when transport locking is used.

Locking may also be fitted in other cases if severe transport conditions are expected.

Bearing seals

Table below present the standard and alternative and types of bearing seals per motor size.

Bearing seals

Motor size	Number of poles	Standard design		Alternative design	
		D-end	N-end	Radial seal at D-end (variant code 072) ¹⁾	Labyrinth seal at D-end (variant code 783) ¹⁾
80	2 – 8	Gamma seal	Gamma seal	Radial seal	NA
90	2 – 8	Gamma seal	Gamma seal	Radial seal	NA
100	2 - 8	Gamma seal	Gamma seal	Radial seal	NA
112	2 – 8	Gamma seal	Gamma seal	Radial seal	NA
132	2 – 8	Gamma seal	Gamma seal	Radial seal	NA
160	2- 8	Gamma seal	Gamma seal	Radial seal	Labyrinth seal
180	2 – 8	Gamma seal	Gamma seal	Radial seal	Labyrinth seal
200	2 – 8	Gamma seal	Gamma seal	Radial seal	Labyrinth seal
225	2 – 8	Gamma seal	Gamma seal	Radial seal	Labyrinth seal
250	2 – 8	Gamma seal	Gamma seal	Radial seal	Labyrinth seal
280	2	Labyrinth seal	V-ring ²⁾	NA	Standard
	4 - 8	V-ring ²⁾	V-ring ²⁾	NA	Labyrinth seal
315SM, ML	2	Labyrinth seal	V-ring ²⁾	NA	Standard
	4 - 8	V-ring ²⁾	V-ring ²⁾	NA	Labyrinth seal
315LK	2- 8	Labyrinth seal	V-ring ²⁾	NA	Standard
355	2 - 12	Labyrinth seal	V-ring	NA	Standard
400	2	Labyrinth seal	Labyrinth seal	NA	Standard
400	4 - 12	Labyrinth seal	V-ring	NA	Standard
450	2 - 12	Labyrinth seal	Labyrinth seal	NA	Standard

¹⁾ N-end bearing seal of standard design, special N-end bearing seal arrangements on request

²⁾ Labyrinth seal as standard on IE3 version

Standard design

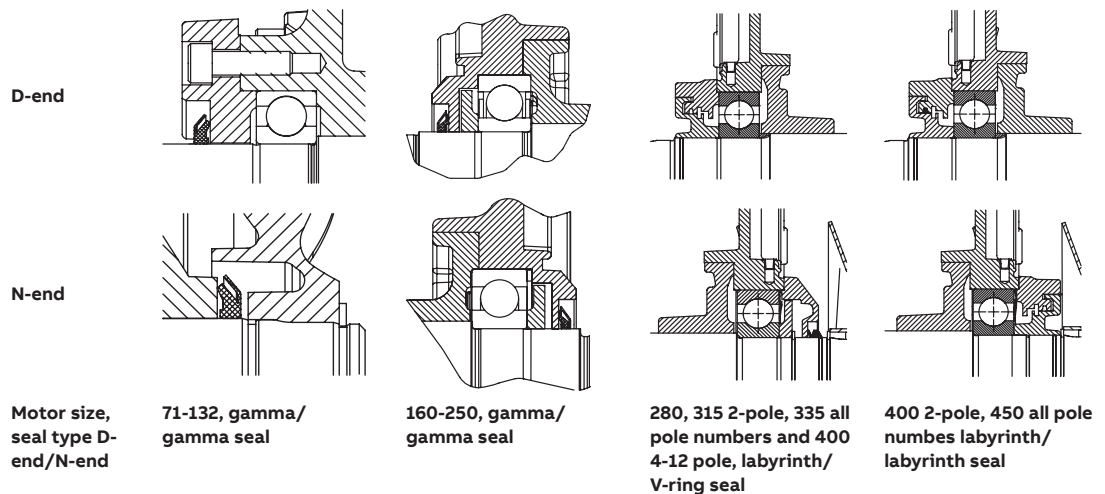

Alternative design

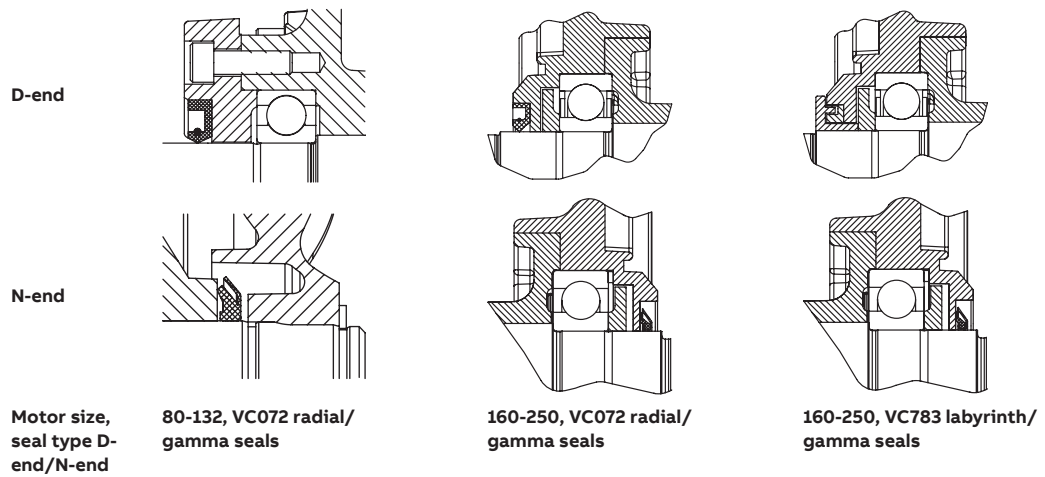

Bearing life and lubrication

The nominal life L_{10h} of a bearing is defined according to ISO 281 as the number of operating hours achieved or exceeded by 90 % of identical bearings in a large test series under specified conditions. 50 % of bearings achieve at least five times this lifetime.

The calculated bearing life L_{10h} for power transmission by means of coupling is for horizontally mounted motors in sizes up to 315 \geq 100,000 hours.

Lubrication

On delivery, motors in frame size 160 and above are pre-lubricated with high-quality grease. Before first start-up, see instructions for re-lubrication and recommended grease in the installation, operation, maintenance and safety manual for low voltage motors for explosive atmospheres delivered together with the motor, or see the lubrication plate on the motor.

Motors with bearings greased for life

Motors in frame sizes 71-132 are equipped with bearings greased for life, while this is available as an option for frame sizes 160-250. Bearings are lubricated with high-quality, high-temperature grease. Bearing types are stated on the rating plate.

The approximate lifetime of bearings in four-pole motors is about 40 0000 duty hours. Lifetime is subject to the load conditions of the application run by the motor.

Motors with re-lubrication nipples

In frame sizes 160-400, the bearing system is provided with valve discs to ease lubrication. Motors are lubricated while running. The grease outlet opening has closing valves at both ends. These should be opened before greasing and closed 1-2 hours after re-greasing. This ensures that the construction is tight and bearings remain dust- and dirt-free.

A grease-collection method can be used optionally.

The following tables show lubrication intervals according to the L_1 principle for various nominal speeds in 25 °C ambient temperature. These values apply to horizontally mounted motors (B3) with 80 °C bearing temperature and high-quality grease containing lithium-complex soap and mineral or PAO-oil.

Lubrication intervals in duty hours for ball bearings

Frame size	Amount of grease g/bearing	Amount of grease g/N-end	Output kW	Speed 3600 r/min	Speed 3000 r/min	Output kW	Speed 1800 r/min	Speed 1500 r/min	Output kW	Speed 1000 r/min	Output kW	Speed 500-900 r/min
Ball bearings												
Lubrication intervals in duty hours												
160	13	13	≤ 18.5	9000	12 000	≤ 15	18 000	21 500	≤ 11	24 000	all	24 000
160	13	13	> 18.5	7500	10 000	> 15	15 000	18 000	> 11	22 500	all	24 000
180	15	15	≤ 22	7000	9000	≤ 22	15 500	18 500	≤ 15	24 000	all	24 000
180	15	15	> 22	6000	8500	> 22	14 000	17 000	> 15	21 000	all	24 000
200	20	15	≤ 37	5500	8000	≤ 30	14 500	17 500	≤ 22	23 000	all	24 000
200	20	15	> 37	3000	5500	> 30	10 000	12 000	> 22	16 000	all	20 000
225	23	20	≤ 45	4000	6500	≤ 45	13 000	16 500	≤ 30	22 000	all	24 000
250	23	20	> 45	1500	2500	> 45	5000	6000	> 30	8000	all	10 000
250	30	23	≤ 55	2500	4000	≤ 55	9000	11 500	≤ 37	15 000	all	18 000
250	30	23	> 55	1000	1500	> 55	3500	4500	> 37	6000	all	7000
280	35	35	all	1900	3200		-	-		-		-
280	40	40		-	-	all	7800	9600	all	13 900	all	15 000
315	35	35	all	1900	3200		-	-		-		-
315	55	40		-	-	all	5900	7600	all	11 800	all	12 900
355	35	35	all	1900	3200		-	-		-		-
355	70	40		-	-	all	4000	5600	all	9600	all	10 700
400	40	40	all	1500	2700		-	-		-	-	-
400	85	55		-	-	all	3200	4700	all	8600	all	9700
450	40	40	all	1500	2700		-	-		-		-
450	95	70		-	-	all	2500	3900	all	7700	all	8700

Lubrication intervals in duty hours for roller bearings

Frame size	Amount of grease g/bearing	Amount of grease g/N-end	Output kW	Speed 3600 r/min	Speed 3000 r/min	Output kW	Speed 1800 r/min	Speed 1500 r/min	Output kW	Speed 1000 r/min	Output kW	Speed 500-900 r/min
Roller bearings												
Lubrication intervals in duty hours												
160	13	13	≤ 18.5	4500	6000	≤ 15	9000	10 500	≤ 11	12 000	all	12 000
160	13	13	> 18.5	3500	5000	> 15	7500	9000	> 11	11 000	all	12 000
180	15	15	≤ 22	3500	4500	≤ 22	7500	9000	≤ 15	12 000	all	12 000
180	15	15	> 22	3000	4000	> 22	7000	8500	> 15	10500	all	12 000
200	20	15	≤ 37	2750	4000	≤ 30	7000	8500	≤ 22	11 500	all	12 000
200	20	15	> 37	1500	2500	> 30	5000	6000	> 22	8000	all	10 000
225	23	20	≤ 45	2000	3000	≤ 45	6500	8000	≤ 30	11 000	all	12 000
225	23	20	> 45	750	1250	> 45	2500	3000	> 30	4000	all	5000
250	30	23	≤ 55	1000	2000	≤ 55	4500	5500	≤ 37	7500	all	9000
250	30	23	> 55	500	750	> 55	1500	2000	> 37	3000	all	3500
280	35	35	all	900	1600		-	-		-		-
280	40	40		-	-	all	4000	5300	all	7000	all	8500
315	35	35	all	900	1600		-	-		-		-
315	55	40		-	-	all	2900	3800	all	5900	all	6500
355	35	35	all	900	1600		-	-		-		-
355	70	40		-	-	all	2000	2800	all	4800	all	5400
400	40	40	all	-	1300		-	-		-		-
400	85	55		-	-	all	1600	2400	all	4300	all	4800
450	40	40	all	-	1300		-	-		-		-
450	95	70		-	-	all	1300	2000	all	3800	all	4400

Mechanical design

Radial forces

Pulley diameter

When the desired bearing life has been determined, the minimum permissible pulley diameter can be calculated with F_R as follows:

$$D = \frac{1.9 \cdot 10^7 \cdot K \cdot P}{n \cdot F_R}$$

Where:

D:	pulley diameter, mm
P:	power requirement, kW
n:	motor speed, r/min.
K:	belt tension factor, dependent on belt type and type of duty. A common value for V-belts is 2.5
F_R :	permissible radial force, refer to tables below.

Permissible loading on the shaft

The following table shows permissible radial forces on the shaft in Newtons, assuming zero axial force, a 25 °C ambient temperature, and normal conditions. The values are given for a calculated bearing life L_{10h} of 40 000 hours per motor size.

These calculated values further assume mounting position IM B3 (foot-mounted), with force directed sideways. In some cases, the strength of the shaft together with frame path dimensions affects permissible forces.

Permissible radial forces

Motor size	Poles	Length of shaft extension E (mm)	Basic design with deep groove ball bearings				Roller bearings			
			Mounting arrangement IM B3							
			20,000 h		40,000 h		20,000 h		40,000 h	
F_{X0} (N)	F_{Xmax} (N)	F_{X0} (N)	F_{Xmax} (N)	F_{X0} (N)	F_{Xmax} (N)	F_{X0} (N)	F_{Xmax} (N)			
71	2	30	540	460	420	360	1285	650	1040	650
	4	30	700	605	555	480	1615	650	1310	650
	6	30	780	665	620	530	1640	650	1450	650
	8	30	860	730	685	580	1640	600	1580	650
80	2	40	710	600	385	350	1910	865	1555	865
	4	40	940	810	725	625	2335	865	1945	865
	6	40	1060	895	840	710	2335	865	2160	865
	8	40	1185	1020	940	810	2335	865	2335	865
90	2	50	820	690	650	545	2205	1330	1790	1330
	4	50	1035	870	820	690	2715	1330	2205	1330
	6	50	1185	995	940	790	3065	1330	2490	1330
	8	50	1300	1095	1035	870	3340	1330	2715	1330

Permissible loads of simultaneous radial and axial forces can be supplied on request.

If the radial force is applied between points X_0 and X_{max} , the permissible force F_R can be calculated with the following formula:

$$F_R = F_{X0} - \frac{X}{E} (F_{X0} - F_{Xmax})$$

Where:

E:	length of the shaft extension in the standard version
----	---

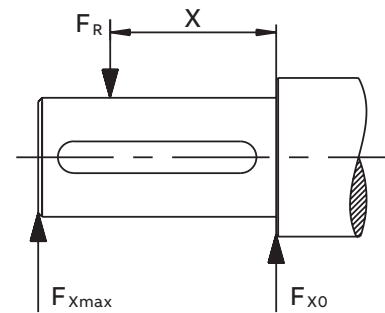

Permissible radial forces

		Basic design with deep groove ball bearings				Roller bearings				
Motor size	Poles	Length of shaft extension E (mm)	Mounting arrangement IM B3							
			20,000 h		40,000 h		20,000 h		40,000 h	
			F_{x0} (N)	F_{xmax} (N)	F_{x0} (N)	F_{xmax} (N)	F_{x0} (N)	F_{xmax} (N)	F_{x0} (N)	F_{xmax} (N)
100	2	60	1130	925	900	735	2905	1900	2360	1900
	4	60	1425	1165	1135	925	3575	1900	2905	1900
	6	60	1635	1335	1295	1060	4040	1900	3280	1900
	8	60	1820	1520	1445	1205	4460	1900	3620	1900
112	2	60	1170	980	925	775	3000	1970	2435	1970
	4	60	1475	1235	1170	980	3695	1970	3000	1970
	6	60	1690	1310	1340	1120	4170	1970	3390	1970
	8	60	1860	1310	1475	1235	4550	1970	3695	1970
132	2	80	1840	1500	1460	1190	4255	3465	3455	2815
	4	80	2320	1890	1840	1500	5240	4265	4255	3465
	6	80	2660	2165	2110	1715	5915	3680	4805	3680
	8	80	2925	2380	2320	1890	6450	3680	5240	3680
160 MLA	2	110	3540	2740	2955	2285	7100	4300	6140	4300
	4	110	4000	3100	3325	2570	8000	4300	6870	4300
	6	110	4170	3200	3440	2655	8600	4300	7270	4300
	8	110	4600	3585	3855	2985	9300	4300	7955	4300
160 MLB	2	110	3540	2740	2955	2270	7085	4300	6070	4300
	4	110	4085	3300	3370	2725	8300	4300	7055	4300
	6	110	4100	3355	3400	2755	8600	4300	7300	4300
	8	110	4200	3270	3455	2670	9000	4300	7570	4300
160 MLC	2	110	3400	2600	2855	2200	6800	4300	5885	4300
	4	110	3700	3000	3070	2485	7800	4300	6640	4300
	6	110	3600	2900	2870	2325	8000	4300	6700	4300
	8	110	4170	3370	3370	2725	9000	4300	7585	4300
160 MLD	2	110	3585	2900	3000	2440	7100	4300	6140	4300
	4	110	3400	2755	2755	2240	7600	4300	6370	4300
160 MLE	2	110	3185	2570	2640	2140	6785	4300	5770	4300
180 MLA	2	110	4100	3385	3455	2825	8125	5500	7025	5500
	4	110	4270	3485	3525	2885	8600	5500	7300	5500
	6	110	4700	3800	3855	3155	9400	5500	7900	5500
	8	110	4785	3900	3870	3170	9800	5500	8255	5500
180 MLB	2	110	4170	3400	3470	2825	7900	5500	6770	5500
	4	110	4185	3400	3440	2810	8500	5500	7200	5500
	6	110	4370	3570	3525	2885	9000	5500	7600	5500
180 MLC	4	110	3700	3055	3010	2470	7900	5500	6655	5440
200 MLA	2	110	5600	4685	4700	3925	10900	9100	9470	7900
	4	110	6285	5200	5240	4370	12500	9550	10700	8900
	6	110	6800	5700	5700	4770	13600	9550	11670	9550
	8	110	6800	5700	5600	4685	14100	9550	12000	9550
200 MLB	2	110	5670	4700	4700	3925	11000	9200	9500	7900
	4	110	5700	4700	4700	3925	12000	9550	10185	8500
	6	110	6400	5370	5300	4425	13200	9550	11200	9385
200 MLC	2	110	5000	4185	4185	3500	10400	8700	8900	7455
	4	110	5400	4500	4425	3685	11600	9550	9800	8200
	6	110	5800	4885	4740	3955	12500	9550	10600	8800
200 MLD	2	110	4985	4170	4170	3485	10400	8700	8900	7400
225 SMA	2	110	6400	5400	5355	4500	13300	10700	11500	9700
	4	140	7300	5900	6155	4970	15400	10250	13200	10250
	6	140	7600	6200	6370	5140	16400	10250	14000	10250
	8	140	8500	6900	7100	5725	17900	10250	15300	10250
225 SMB	2	110	6100	5185	5155	4340	13000	10700	11200	9455
	4	140	7085	5700	5885	4755	15100	10250	12900	10250
	6	140	7100	5700	5840	4700	16000	10250	13500	10250
	8	140	8000	6485	6600	5340	17300	10250	14700	10250

Permissible radial forces

		Basic design with deep groove Ball bearings				Roller bearings				
Motor size	Poles	Length of shaft extension E (mm)	Mounting arrangement IM B3							
			20,000 h		40,000 h		20,000 h		40,000 h	
			F _{x0} (N)	F _{xmax} (N)	F _{x0} (N)	F _{xmax} (N)	F _{x0} (N)	F _{xmax} (N)	F _{x0} (N)	F _{xmax} (N)
225 SMC	2	110	5600	4700	4685	3940	12600	10600	10770	9070
	4	140	6400	5200	5300	4285	14500	10250	12385	10000
225 SMD	2	110	5500	4640	4600	3880	12420	10460	10640	8960
	4	140	5800	4700	4725	3800	13500	10250	11400	9270
250 SMA	2	140	7700	6285	6500	5285	17100	10900	14900	10900
	4	140	8700	7000	7300	5900	19800	13800	17000	13785
	6	140	9400	7600	7800	6355	21600	13800	18400	13800
	8	140	9600	7800	7900	6400	22700	13800	19300	13800
250 SMB	2	140	7100	5800	6000	4885	16700	10900	14400	10900
	4	140	7800	6300	6470	5240	18900	13800	16200	13100
	6	140	8900	7200	7355	5955	21200	13800	18000	13800
250 SMC	2	140	6800	5500	5670	4600	16300	10900	14000	10900
	4	140	7400	6000	6055	4900	18100	13800	15400	12485
	6	140	8200	6600	6670	5400	20300	13800	17200	13800
280 SM_	2	140	7300	6000	5800	4900	20400	6000	16500	6000
	4	140	9200	7800	7300	6200	25100	9200	20300	9200
	6	140	10600	8900	8400	7000	28300	9200	23000	9200
	8	140	11700	9200	9200	7800	30900	9200	25100	9200
280 ML_	2	140	7400	6200	5800	5000	20600	6200	16700	6200
	4	140	9200	7900	7300	6200	25000	9500	20300	9500
	6	140	10500	9000	8300	7100	28300	9400	22900	9400
	8	140	11600	9500	9200	7900	30800	9500	25000	9500
315 SM_	2	140	7300	6000	5800	4950	20300	6000	16500	6000
	4	170	11400	9400	9000	7450	32500	9600	26600	9600
	6	170	13000	9600	10300	8500	37000	9600	30000	9600
	8	170	14400	9600	11400	9400	40300	9600	32700	9600
315 ML_	2	140	7400	6400	5850	5050	20600	5850	16700	5850
	4	170	11500	9700	9100	7650	32700	13600	26500	13600
	6	170	13200	11100	10400	8800	36900	13600	29900	13600
	8	170	14500	12200	11500	9700	40200	13600	32600	13600
315 LK_	2	140	7400	6550	5800	5150	20800	5550	16800	5550
	4	170	11500	10000	9100	7850	33100	13350	26800	13350
	6	170	13200	11400	10450	9050	37300	13350	30300	13350
	8	170	14600	12600	11550	10000	40800	13350	33100	13350
355 SM_	2	140	7350	6450	5750	5050	20600	7200	16700	7200
	4	210	15200	12600	12000	9950	45500	14000	36900	14000
	6	210	17500	14000	13800	11400	51400	14000	41700	14000
	8	210	19300	14000	15250	12600	56000	14000	45500	14000
355 ML_	2	140	7350	6550	5750	5100	20800	6750	16800	16800
	4	210	15300	12900	12000	10100	45900	13600	37200	13600
	6	210	17600	13600	13900	11600	51500	13600	42100	13600
	8	210	19400	13600	15300	12900	56000	13600	45900	13600
355 LK_	2	140	7350	6650	5650	5100	21000	6550	17000	6550
	4	210	15200	13000	11850	10200	46000	13000	37300	13000
	6	210	17500	13000	13700	11900	52000	13000	42000	13000
	8	210	19400	13000	15200	13000	56500	13000	46000	13000
400 L_	2	170	7650	6850	4400	3900	23900	9050	19350	9050
	4	210	15600	13550	12150	10550	52500	16000	43300	16000
	6	210	17800	15450	13850	12000	60000	16000	48800	16000
	8	210	19700	16000	15350	13350	65700	16000	53200	16000
400 LK_	2	170	7650	6850	4400	3900	23900	9050	19350	9050
	4	210	15600	11500	12150	10550	52500	11500	43300	11500
	6	210	17800	11500	13850	11500	60000	11500	48800	11500
	8	210	19700	11500	15350	11500	65700	11500	53200	11500
450 L_	2	170	7400	6700	3500	3300	24000	7500	19000	7500
	4	210	17000	15200	13000	11600	62000	25000	50000	25000
	6	210	19000	17000	14000	13000	70000	24000	56000	24000
	8	210	21300	19000	16500	14600	76000	23000	62000	23000

Mechanical design

Axial forces

01 Mounting arrangement IM B3.

02 Mounting arrangement IM V1.

The following tables present permissible axial forces on the shaft in Newtons, assuming zero radial force, a 25 °C ambient temperature, and normal conditions. The values are given for a calculated bearing life of 20,000 and 40,000 hours per motor size.

At 60 Hz, the values must be reduced by 10 percent, and for two-speed motors, the higher speed determines permissible axial force. Permissible loads of simultaneous radial and axial forces can be supplied on request.

For axial force F_{AD} , it is assumed that the D-bearing is locked with a locking ring.

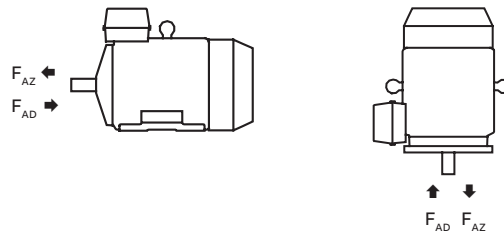

01

02

Permissible axial forces

Motor size	Poles	Length of shaft extension E (mm)	Mounting arrangement IM B3				Mounting arrangement IM V1			
			Deep groove ball bearings				Deep groove ball bearings			
			20,000 h		40,000 h		20,000 h		40,000 h	
			F_{AD} (N)	F_{AZ} (N)	F_{AD} (N)	F_{AZ} (N)	F_{AD} (N)	F_{AZ} (N)	F_{AD} (N)	F_{AZ} (N)
71	2	30	615	285	505	175	630	275	520	165
	4	30	760	430	615	285	790	410	645	265
	6	30	870	540	695	365	890	525	720	355
	8	30	960	630	765	435	985	615	785	415
80	2	40	880	300	735	155	915	280	770	135
	4	40	1075	495	880	300	1130	455	935	260
	6	40	1215	635	985	405	1270	600	1040	370
	8	40	1330	750	1070	490	1400	705	1140	450
90	2	50	780	500	620	340	840	455	680	300
	4	50	985	705	775	495	1070	650	860	440
	6	50	1140	860	890	610	1225	800	975	555
	8	50	1265	985	985	705	1355	925	1075	645
100	2	60	925	570	735	350	1285	510	1060	290
	4	60	1480	860	1190	570	1600	780	1305	490
	6	60	1690	1070	1350	730	1815	995	1470	650
	8	60	1865	1245	1480	860	1995	1160	1610	775
112	2	60	1155	595	935	375	1290	505	1070	280
	4	60	1445	885	1155	595	1595	785	1300	495
	6	60	1655	1095	1315	755	1810	995	1465	650
	8	60	1830	1270	1445	885	1985	1170	1600	780

Permissible axial forces

Motor size	Poles	Length of shaft extension E (mm)	Mounting arrangement IM B3				Mounting arrangement IM V1			
			Deep groove ball bearings				Deep groove ball bearings			
			20,000 h		40,000 h		20,000 h		40,000 h	
			F _{AD} (N)	F _{AZ} (N)	F _{AD} (N)	F _{AZ} (N)	F _{AD} (N)	F _{AZ} (N)	F _{AD} (N)	F _{AZ} (N)
132	2	80	1765	965	1420	620	1925	855	1580	510
	4	80	2210	1410	1755	955	2420	1270	1965	815
	6	80	2535	1735	2000	1200	2770	1580	2235	1045
	8	80	2800	2000	2205	1405	3055	1835	2455	1235
160 MLA	2	110	2850	2850	2325	2325	3100	2578	2570	2048
	4	110	3450	3450	2775	2775	3820	3150	3120	2450
	6	110	3690	3690	2970	2970	4100	3410	3325	2635
	8	110	4155	4155	3315	3315	4440	3845	3640	3045
160 MLB	2	110	2850	2850	2325	2325	3120	2570	2580	2030
	4	110	3435	3435	2760	2760	3880	3085	3180	2385
	6	110	3600	3600	2880	2880	4120	3240	3360	2480
	8	110	3750	3750	2970	2970	4140	3450	3340	2650
160 MLC	2	110	2775	2775	2280	2280	3080	2500	2560	1980
	4	110	3150	3150	2535	2535	3620	2770	2985	2135
	6	110	3135	3135	2490	2490	3680	2700	3005	2025
	8	110	3675	3675	2910	2910	4240	3260	3445	2465
160 MLD	2	110	2865	2865	2330	2330	3220	2540	2665	1985
	4	110	2900	2900	2320	2320	3420	2470	2820	1870
160 MLE	2	110	2500	2500	2025	2025	2900	2150	2420	1670
180 MLA	2	110	3300	3300	2700	2700	3660	2940	3060	2340
	4	110	3600	3600	2920	2920	4160	3150	3460	2450
	6	110	4140	4140	3320	3320	4800	3675	3940	2815
	8	110	4220	4220	3360	3360	4960	3740	4040	2820
180 MLB	2	110	3340	3340	2725	2725	3760	2960	3125	2320
	4	110	3580	3580	2900	2900	4220	3095	3500	2375
	6	110	3800	3800	3040	3040	4500	3285	3700	2485
180 MLC	4	110	3220	3220	2560	2560	3880	2660	3220	2000
200 MLA	2	110	4460	4460	3640	3640	5000	3965	4200	3125
	4	110	5000	5260	4260	4260	5000	4680	5000	3640
	6	110	5000	5480	4720	4720	5000	5265	5000	4065
	8	110	5000	5880	4700	4700	5000	5195	5000	3955
200 MLB	2	110	4440	4440	3620	3620	5000	3905	4220	3085
	4	110	4720	4720	3840	3840	5000	4060	4700	3120
	6	110	5000	5480	4420	4420	5000	4800	5000	3660
200 MLC	2	110	3940	3940	3180	3180	4600	3385	3880	2665
	4	110	4480	4480	3620	3620	5000	3775	4520	2875
	6	110	4980	4980	3980	3980	5000	4165	5000	3105
200 MLD	2	110	3940	3940	3200	3200	4660	3370	3925	2635
225 SMA	2	110	4980	4980	4060	4060	5000	4375	4780	3455
	4	140	5000	6080	4920	4920	5000	5445	5000	4225
	6	140	5000	6520	5000	5260	5000	5735	5000	4395
	8	140	5000	7420	5000	5960	5000	6535	5000	5095
225 SMB	2	110	4860	4860	3960	3960	5000	4245	4780	3345
	4	140	5000	5880	4780	4780	5000	5175	5000	3995
	6	140	5000	6020	4840	4840	5000	5155	5000	3915
	8	140	5000	6940	5000	5560	5000	6055	5000	4635
225 SMC	2	110	4380	4380	3540	3540	5000	3670	4440	2900
	4	140	5000	5240	4260	4260	5000	4445	5000	3425
225 SMD	2	110	4320	4320	3480	3480	5000	3590	4400	2790
	4	140	4800	4800	3820	3820	5000	3895	5000	2935

Permissible axial forces

Motor size	Poles	Length of shaft extension E (mm)	Mounting arrangement IM B3				Mounting arrangement IM V1			
			Deep groove ball bearings				Deep groove ball bearings			
			20,000 h		40,000 h		20,000 h		40,000 h	
			F _{AD} (N)	F _{AZ} (N)	F _{AD} (N)	F _{AZ} (N)	F _{AD} (N)	F _{AZ} (N)	F _{AD} (N)	F _{AZ} (N)
250 SMA	2	140	6000	6080	4920	4920	6000	5345	5840	4225
	4	140	6000	7140	5820	5820	6000	6300	6000	4920
	6	140	6000	7880	6000	6380	6000	6950	6000	5350
	8	140	6000	8200	6000	6600	6000	7125	6000	5385
250 SMB	2	140	5620	5620	4540	4540	6000	4830	5640	3810
	4	140	6000	6320	5100	5100	6000	5325	6000	4085
	6	140	6000	7480	6000	6040	6000	6370	6000	4830
250 SMC	2	140	5260	5260	4220	4220	6000	4395	5400	3415
	4	140	5960	5960	4760	4760	6000	4900	6000	3700
	6	140	6000	6860	5520	5520	6000	5575	6000	4135
280 SM_	2	140	6200	4250	4900	2900	7550	3150	6200	1800
	4	140	8000	6000	6250	4250	9600	4550	7800	2750
	6	140	7250	9250	7150	5150	11150	5500	9000	3350
	8	140	10300	8300	7950	5950	12200	7000	9850	4700
280 ML_	2	140	6100	4100	4800	2800	8150	2750	6800	1400
	4	140	7800	5800	6000	4000	10450	4050	8650	2250
	6	140	8950	6950	6900	4900	12350	4750	10250	2600
	8	140	10000	8000	7700	5700	13450	5800	11050	3450
315 SM_	2	140	6180	4200	4850	2850	7950	2600	6600	1300
	4	170	9400	7400	7250	5250	11750	5500	9550	3300
	6	170	10900	8900	8350	6350	13600	6300	11050	3750
	8	170	12000	10000	9200	7000	15350	7900	12450	5000
315 ML_	2	140	6050	4050	4750	2750	8650	2300	7300	¹⁾
	4	170	9250	7250	7100	5100	12500	5050	10300	2900
	6	170	10650	8650	8100	6100	14900	5800	12350	3250
	8	170	11500	9900	8900	6800	15400	6300	13600	3400
315 LK_	2	140	6000	3950	4650	2650	9100	1350	7750	¹⁾
	4	170	9100	7150	7000	5000	13100	3850	10900	1700
	6	170	10500	8500	7950	5950	15700	4100	13100	1550
	8	170	11750	9750	8900	6900	16900	6300	14100	3450
355 SM_	2	140	3050	6850	1750	5550	6350	4250	4950	2900
	4	210	8600	12400	5900	9700	13250	8600	10450	5850
	6	210	10550	14350	7300	11100	15650	9580	12350	6270
	8	210	12200	16000	8550	12350	17350	12500	13600	8900
355 ML_	2	140	2900	6700	1600	5400	7100	3700	5750	2350
	4	210	8360	12150	5650	9450	14600	7950	11850	5150
	6	210	10100	13900	6900	10700	18050	8600	14700	5300
	8	210	12000	15800	7300	11000	21100	11650	17000	7600
355 LK_	2	140	2650	6450	1350	5150	8250	2650	6900	1300
	4	210	8200	12000	5450	9250	15650	6600	12850	3800
	6	210	9900	13700	6700	10500	19100	7050	15800	3750
	8	210	11450	15250	7800	11600	21200	8700	17500	5000
400 L, LK_	2	170	2150	7150	¹⁾	5800	8650	2150	7220	¹⁾
	4	210	7100	13100	4300	10300	16050	6400	13150	3400
	6	210	8850	14850	5500	11500	18450	6750	15100	3400
	8	210	10450	16450	6750	12750	20100	8350	16450	4700
450 L_	2	170	1800	6800	¹⁾	5500	11500	¹⁾	10000	¹⁾
	4	210	7600	13500	4500	10500	20000	4400	17700	1200
	6	210	9000	15000	5600	11500	26000	3700	22200	¹⁾
	8	210	10800	16800	7000	12900	27800	5500	23700	1350

¹⁾ On request.

Terminal box

Standard terminal box

Protection and mounting options

The degree of protection for the standard terminal box is IP 55 or IP65 depending on the equipment protection level and dust category. It complies with the requirements of the protection method 't' dust ignition protection and prevents all ignition sources such as sparks, excessive over heating etc. All terminal box seals are of uninterrupted type fulfilling the requirements for Ex t motors. By default, terminal boxes are mounted on top of the motor at D-end. Side mounted terminal box is possible in frame sizes 160-400. Mounting at N-end is possible for the larger frame sizes. Please refer to the variant code section for more details.

Turnability

The standard terminal boxes for motor sizes 160 - 315 can be turned 4*90° and in sizes 355-450 2*180° after delivery. For sizes 355-450 is also mounting of terminal box with opening towards D or N-end possible using the relevant variant codes when ordering, this is needed to get the terminal block turned in the right position. For motors in size 71-132 is 4*90° turnable terminal box optional, this can be ordered with variant code 400.

Cable entries

Terminal box is provided as standard with tapped holes for cable glands, no cable glands are included as standard. The entry holes are closed with Ex t approved blanking plugs made of nickel-plated brass, one of the main entries is closed with a plastic plug as transport and storage protection. Please refer to the table on next page for further information about amount and size of threaded holes, plugs provided as standard.

Different types of cable glands are available as option, suitable for either armoured and non-armoured cables, please refer to the Terminal box alternatives section for more details.

Cable type and terminations

Terminations are suitable for copper and aluminum cables (Al- cables on request for motor sizes 160 to 250). Cables are connected to terminals by cable lugs, which are not included in the delivery.

Earthing bolts

The motors are as standard provided with at least one earthing bolt inside the terminal box and another on the frame. The earthing bolt on the frame is located on top close to the terminal box, motors in size 160-250 is the earthing bolt located on RHS foot (seen from D-end).

Ordering

To ensure the delivery of desired terminations and cable entries for the motor, state the cable type, quantity, size, outer diameter and possibly type of cable glands needed when ordering.

See section Variant codes for all options available.

Standard delivery

Standard delivery if no other information is provided.

Motor size	Pole number	Terminal box type	Size of gland plate opening on terminal box	45° angle adapter	Amount and size of threaded plugged holes	Max. connectable core cross section mm ² /phase	Number and size of terminal bolts
IE2 and IE3 motors							
71	2-8	integr.	-	-	2xM16x1.5	1x2.5	6 x M4
80	2-8	integr.	-	-	2xM25x1.5	1x4	6 x M4
90	2-8	integr.	-	-	2xM25x1.5	1x6	6 x M5
100-132	2-8	integr.	-	-	2xM32x1.5	1x10	6 x M5
160-180	2-8	63	B	-	2xM40x1.5	1x35	6 x M6
200-250	2-8	160	C	-	2xM63x1.5	1x70	6 x M10
280	2-8	370/1	D	-	2xM63x1.5	2x150	6 x M12
315SM_, ML_	2-8	370/1	D	-	2xM63x1.5	2x240	6 x M12
315LKA, LKB	2-4	370/1	D	-	2xM63x1.5	2x240	6 x M12
315LKC	2-4	750/1	E	-	2xM75x1.5	4x240	6 x M12
315LK_	6-8	370/1	D	-	2xM63x1.5	2x240	6 x M12
355SMA - SMC	2-4	750/1	E	-	2xM75x1.5	4x240	6 x M12
355SMA, SMB	6-8	370/1	D	-	2xM63x1.5	2x240	6 x M12
355SMC	6	750/1	E	-	2xM75x1.5	4x240	6 x M12
355SMC	8	370/1	D	-	2xM63x1.5	2x240	6 x M12
355MLA	2-4	750/1	E	-	2xM75x1.5	4x240	6 x M12
355MLB, LK_	2-4	750/1	E	E-2D	4xM75x1.5	4x240	6 x M12
355ML_, LK_	6-8	750/1	E	-	2xM75x1.5	4x240	6 x M12
400	2-8	750/1	E	E-2D	4xM75x1.5	4x240	6 x M12
450 LA	4	1200/1	E	E-2D	4xM75x1.5	6x240	6 x M12
450 LB, LC	2-4	1200/1	E	E-2D	4xM75x1.5	6x240	6 x M12
450 LA	6	750/1	E	E-2D	4xM75x1.5	4x240	6 x M12
450 LB, LC	6	1200/1	E	E-2D	4xM75x1.5	6x240	6 x M12
450	8	750/1	E	E-2D	4xM75x1.5	4x240	6 x M12
Auxiliary cable entries							
160 - 450	2-8				2xM20x1.5	1x 2.5	

Motor size	Earthing on frame	Earthing in main terminal box
71-112	M4	M4
132	M5	M5
160-250	clamp	M6
280-400	M10	2xM10
450	M10	4xM12

Terminal box

Terminal box dimensions

01 Terminal box type 63 and 160

02 Terminal box types 210 and 370

03 Terminal box type 750 + adapter

04 Terminal box type 1200 + adapter

For motor sizes 71 to 132 the terminal box is integrated in motor frame and the dimensions for terminal boxes can be found in the motor dimension drawings in ABB Library.

To match the correct terminal box with motor sizes 160-450, find the motor type and correspondent terminal box type on the previous page. The box types and their dimensions are presented on this page.

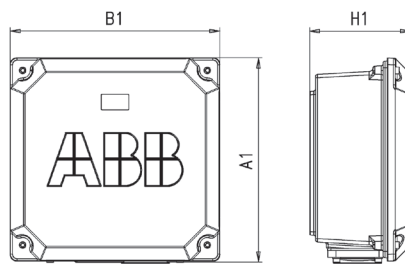

01

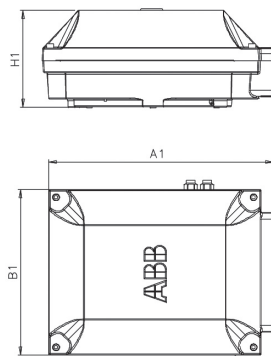

02

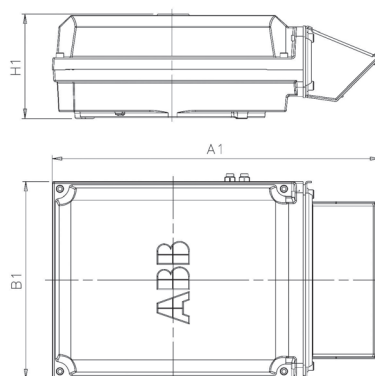

03

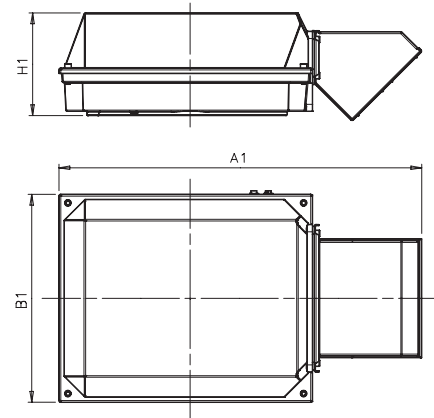

04

Terminal box types acc. to current capacity	A1	B1	H1	Gland plate opening
63	247	247	109	B
160	300	310	154	C
370/1	467	348	207	D
750 /1	549	433	231	E
1200/1	740	591	290	E

Dimensions for terminal box inlets

Corresponds to motor sizes 160 and above

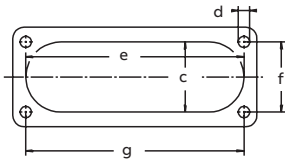

Flange opening	c mm	e mm	f mm	g mm	d thread type
B	31	120	30	120	M6
C *)	71	194	62	193	M6
C **)	67	193	62	193	M8
D	100	300	80	292	M10
E	115	370	100	360	M12

Note! The C flange is different depending on frame size

*) for frame sizes 200-225

***) for frame size 280

Terminal box

Terminal boxes and boards

01 Integrated terminal box for motor sizes 71-132. Tapped holes for cable entries.

02 Terminal board for motor sizes 90-112, IE2, and 90-100, IE3.

03 Terminal box for motor sizes 160-250. Connection flanges with tapped cable entries.

04 Terminal board for motor sizes 71-80.

05 Terminal board for motor size 132, IE2, and motor sizes 112-132, IE3.

06 Terminal board for motor sizes 160-250.

The pictures below show standard terminal boxes and the corresponding terminal boards for various motor sizes.

Motor sizes 71-250



01

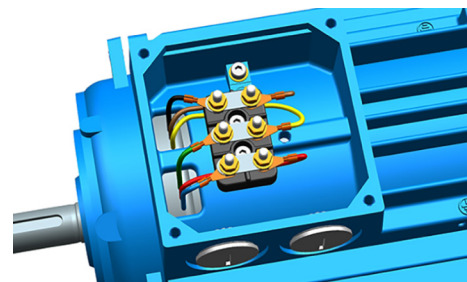

04

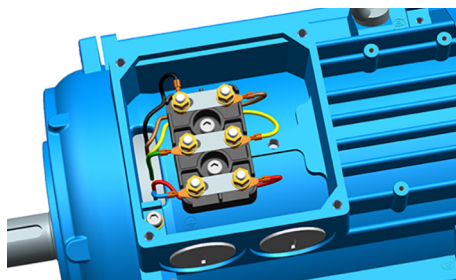

02

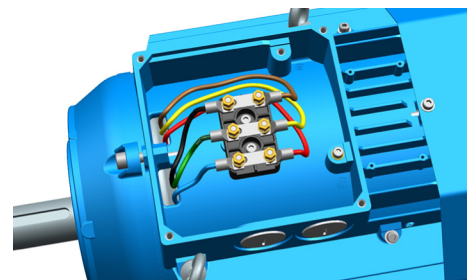

05

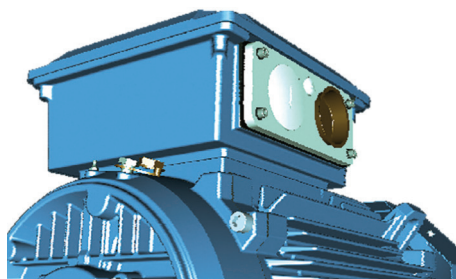

03

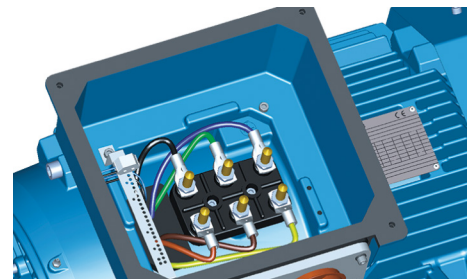

06

—
07 Terminal box for motor sizes 280-355SM.

Motor sizes 280-450

08 Terminal board for motor sizes 280 - 315.

09 Terminal box with angle adapter for motor sizes 355ML - 450.

10 Terminal board for motor sizes 355 to 400.

11 Terminal board for motor size 450.

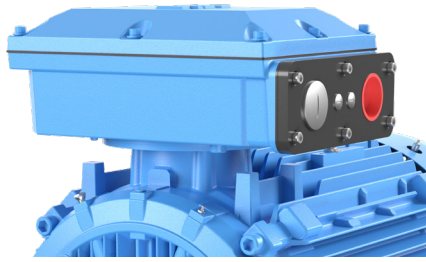

—
07

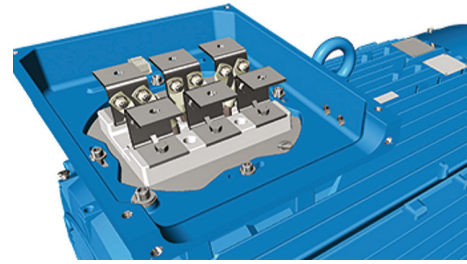

—
10



—
08

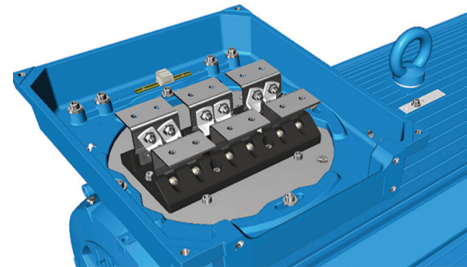

—
11

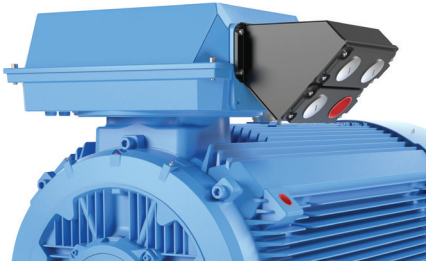

—
09

Terminal box

Terminal box alternatives

Optional cable termination parts

There is a broad selection of cable termination accessories available to allow a safe and reliable termination of one or several supply cables. The most common options are explained in this chapter.

How to order

- Check first that the terminal box itself allows mounting of the desired cable and cores (refer to table showing standard delivery for each motor size). If very large cable are used might it be necessary to use a larger terminal box and larger terminal board than standard
- Select the right cable gland(s) or cable sealing end unit based on the diameter of the cables(s) and suitability for cable type
- Select appropriate adapter or flange to allow mounting on opening in terminal box

Cable glands

The motors are delivered as standard with plugged cable entries as described in the previous section. There is a broad selection of different type of cable glands available which are suitable for different types of cable and outer diameter ranges.

Ordering example

Motor and supply cables	110kW, 4-pole, 400V 50Hz, IE2. Cables needed: 1 pcs outer diameter 42mm steel wire armoured cable, single cross section 120 mm ² . Cables coming from below.
Motor	M3GP 315SMA 4, B3
Adapter (to allow entry of cables coming from below)	Not possible
Cable glands Ex t suitable for armoured cables (an M50 gland will suit this cable)	Variant code 734 (specify cable dimensions)
Gland plate made of steel drilled and tapped with 1 pcs M50 hole (non-std size)	Variant code 554 (1 pcs M50 x 1.5 threaded hole to be specified)

Size of threaded opening for cable gland	Cable gland(s) nickel plated brass, Ex t, for non armoured cable, variant code 230 or 731	EMC Cable gland(s) nickel plated brass, Ex t, for non armoured cable, variant code 704	Cable gland Ex d / Ex t for armoured cable with double sealing, variant code 734	
Metric (std)	Cable outer diameter, mm	Cable outer diameter, mm	Cable outer diameter, mm	Inner sheath diameter, mm
M16 x 1.5	4-8	4-8	7-12	4.5-8
M20 x 1.5	4-12	4-12	10-16	6-10
M25 x 1.5	-	-	13.5-19	10-14
M25 x 1.5 *)	10-18	10-18	19-25	14-18
M32 x 1.5	14-24	14-24	25-30	18-23
M40 x 1.5	22-32	22-32	30-36	23-28
M50 x 1.5	-	-	36-40	28-32
M50 x 1.5 *)	26-35	26-35	40-46	32-37
M63 x 1.5	-	-	46-53	37-43
M63 x 1.5 *)	35-45	35-45	53-60	43-50
M75 x 1.5	46-62	46-62	58-70	48-60
M90 x 1.5	-	-	78-90	68-80
M100 x 1.5	-	-	88-100	78-90

*)= High capacity version, delivered as standard with the variant code

Threaded openings for cable glands with NPT thread (variant code 730)

The motors are delivered as standard with openings for cable glands with metric threads as listed in the section describing the standard terminal box. If glands with NPT threads will be used must variant code 730 be ordered. If nothing else is stated on the orderer will the sizes in tables below be delivered.

Motor frame size	Main cable entries	NPT plug
160-180	2 x 1 ¼"	1 x 1 ¼"
200-250	2 x 1 ½"	1 x 1 ½"
280	2 x 2"	1 x 2"
315	2 x 2 1/2"	1 x 2 1/2"
355-450	2 x 3"	1 x 3"

Motor frame size	Cable entries for auxiliaries	NPT plug
160-450	2 x ¾"	2 x ¾"

Gland plates with threaded openings for cable glands of nonstandard size

If the standard size of threaded openings for cable glands does not suit the gland size and cable that will be used can openings of nonstandard size also be delivered, either by fitting a reducers to make the openings smaller or by increasing the amount or size of holes. The maximum possible size and amount for each gland plate size is listed below. Threaded openings of non-standard size can be ordered using variant code 554.

Gland plate size	Maximum amount and size of threaded holes
B	2 x M40
C	2 x M63
D	2 x M90 or 3 x M75
E	2 x M90 or 4 x M75

Gland plates of non-standard material

The standard material used in gland plates is steel. Gland plates made of stainless steel are optional, either with cable glands or blind without threaded holes. Please refer to the variant code section for more information.

Auxiliary terminal box

It is possible to equip motors from frame size 160 upwards with one or several auxiliary terminal boxes for connection of auxiliaries like heaters or temperature detectors. The standard auxiliary terminal box is made of aluminium, except frame sizes 160-250 where cast iron boxes are used.

Connection terminals are of spring-loaded type for quick and easy connection. These are suitable for up to 2.5 mm² wires. The auxiliary terminal boxes are equipped with an earthing terminal. The first

auxiliary terminal box is located on the right-hand side at D-end as standard.

The standard cable entry is 2 x M20 with plugged entries. If cable glands are needed must these be ordered using the variant codes described earlier in this section.

Related variant codes

380	Separate terminal box for temperature detectors
418	Separate terminal box for auxiliaries
567	Separate terminal box material: cast Iron
568	Separate terminal box for heating elements

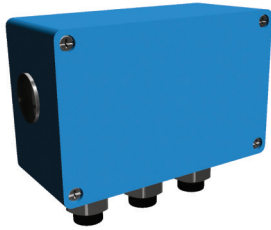

Small auxiliary aluminum terminal box for motor sizes 280-450 (variant codes 418, 568, 380, 569). The size of terminal box ordered with these codes depends on the number of accessories ordered. 80 x 125 mm, max 12 strips. Earthing size M4

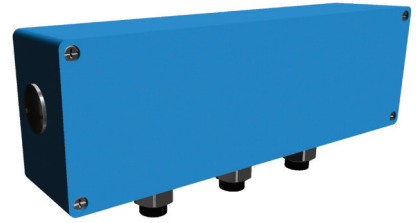

Large auxiliary aluminum terminal box for motor sizes 280-450. The size of terminal box ordered with these codes depends on the number of accessories ordered. 80 x 250 mm, max 30 strips. Earthing size M4

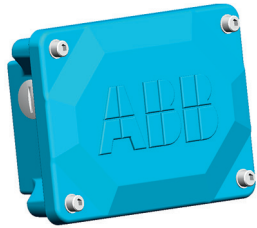

Auxiliary cast iron terminal box for motor size 160-250 (variant code 418). 111 x 162 mm



Auxiliary cast iron terminal box for motor sizes 280-450 (variant code 567). 208 x 180 mm

Dimension drawings

Dust ignition protection Ex t cast iron motors, 2D and 3D

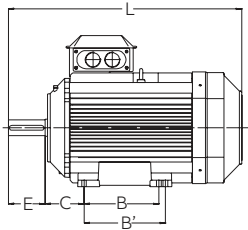

Foot-mounted motor IM 1001, IM B3

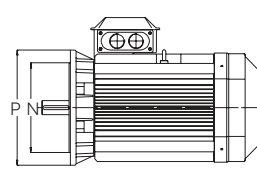
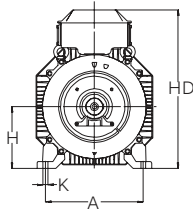

Flange-mounted motor IM 3001, IM B5

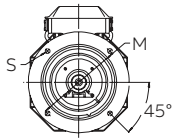
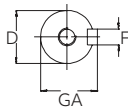
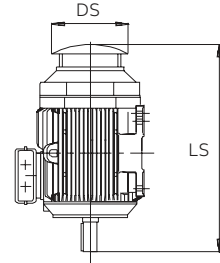

Sizes 80 to 200

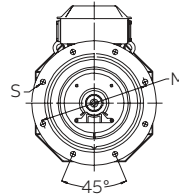

Sizes 225 to 450

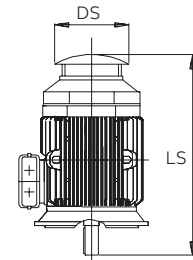

Protective roof, variant code 005

Motor size	IM 1001, IM B3 AND IM 3001, IM B5										IM 1001, IM B3			IM 3001, IM B5			Protective roof							
	D poles		GA poles		F poles		E poles		L max poles		A	B	B'	C	HD	K	H	M	N	P	S	DS	LS	
	2	4-8	2	4-8	2	4-8	2	4-8	2	4-6												2	4-8	
71M_	14	14	16	16	5	5	30	30	264	264	112	90	-	45	178	7	71	130	110	160	10	139	272	272
71ML_	14	14	16	16	5	5	30	30	294	294	112	90	-	45	178	7	71	130	110	160	10	139	302	302
80M_	19	19	21.5	21.5	6	6	40	40	331	331	125	100	-	50	194	10	80	165	130	200	12	157	331	331
80ML_	19	19	21.5	21.5	6	6	40	40	363	363	125	100	112	50	194	10	80	165	130	200	12	157	363	363
90SL_	24	24	27	27	8	8	50	50	356	356	140	100	125	56	218	10	90	165	130	200	12	177	368	368
90L_	24	24	27	27	8	8	50	50	390	390	140	100	125	56	218	10	90	165	130	200	12	177	402	402
100L_	28	28	31	31	8	8	60	60	381	381	160	140	-	63	247	12	100	215	180	250	15	197	395	395
100ML_	28	28	31	31	8	8	60	60	403	403	160	140	-	63	247	12	100	215	180	250	15	197	417	417
100LK_	28	28	31	31	8	8	60	60	435	435	160	140	160	63	247	12	100	215	180	250	15	197	449	449
112 (IE2)	28	28	31	31	8	8	60	60	403	403	190	140	-	70	259	12	112	215	180	250	15	197	417	417
112 (IE3)	28	28	31	31	8	8	60	60	442	403	190	140	-	70	258	12	112	215	180	250	15	222	483	483
132	38	38	41	41	10	10	80	80	532	532	216	140	178	89	300	12	132	265	230	300	15	261	552	552
160	42	42	45	45	12	12	110	110	681	681	254	210	254	108	421	14.5	160	300	250	350	19	305	733	733
180	48	48	51.5	51.5	14	14	110	110	726	726	279	241	279	121	461	14.6	180	300	250	350	19	346	779	779
200	55	55	59	59	16	16	110	110	821	821	318	267	305	133	528	18.5	200	350	300	400	19	386	875	875
225	55	60	59	64	16	18	110	140	849	849	356	286	311	149	573	18.5	225	400	350	450	19	425	902	932
250	60	65	64	69	18	18	140	140	884	884	406	311	349	168	626	24	250	500	450	550	19	471	937	937
280	65	75	69	79.5	18	20	140	140	1088	1088	457	368	419	190	784	24	280	500	450	550	18	555	1180	1190
315SM_	65	80	69	85	18	22	140	170	1174	1204	508	406	457	216	852	30	315	600	550	660	23	624	1290	1320
315ML_	65	90	69	95	18	25	140	170	1285	1315	508	457	508	216	852	30	315	600	550	660	23	624	1401	1431
315LK_	65	90	69	95	18	25	140	170	1491	1521	508	508	560	216	852	28	315	600	550	660	23	624	1607	1637
355SM_	70	100	74.5	106	20	28	140	210	1409	1479	610	500	560	254	978/968 ¹⁾	35	355	740	680	800	23	720	1476	1546
355ML_	70	100	74.5	106	20	28	140	210	1514	1584	610	560	630	254	978	35	355	740	680	800	23	720	1528	1703
355LK_	70	100	74.5	106	20	28	140	210	1764	1834	610	630	710/900	254	978	35	355	740	680	800	23	720	1633	1703
400L_	80	110	85	116	22	28	170	210	1851	1891	710	900	1000	224	1065	35	400	940	880	1000	28	810	1860	1900
400LK_	80	100	85	106	22	28	170	210	1851	1891	686	710	800	280	1065	35	400	740	680	800	24	810	1860	1900
450	-	120	-	127	-	32	-	210	-	2187	800	1000	1120	250	1183/1256 ²⁾	42	450	1080	1000	1150	28	966	-	2342

¹⁾ With 750/370 terminal box

²⁾ With 1200/750 terminal box

IM B14 (IM3601), IM 3602

Motor size	LA	M	N	P	S	T	S	T
71	8	85	70	105	M6	2.5	M6	2.5
80	8	100	80	120	M6	3	M6	3
90	10	115	95	140	M8	3	M8	3
100	10	130	110	160	M8	3.5	M8	3.5
112	10	130	110	160	M8	3.5	M8	3.5
132	12	165	130	200	M10	3.5	M10	3.5

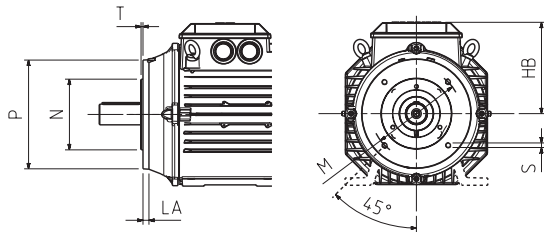

Tolerances

A, B	± 0.8
D, DA	ISO k6 < $\varnothing 48\text{mm}$ ISO m6 > $\varnothing 48\text{mm}$
F, FA	ISO h9
H	-0.5
N	ISO j6
C, CA	± 0.8

In all dimension drawings: The tables give the main dimensions in mm.

For detailed drawings please see our web-pages 'www.abb.com/motors&generators' or contact ABB.

Certificate examples

01 EU Declaration of Conformity.

02 EU Type Examination certificate.

03 IECEx Certificate of Conformity.



EU Declaration of Conformity

The products: 3-phase induction motors for potentially explosive atmospheres as listed in this document on the pages 2...3 having correspondent name plate markings covered by these as listed.

The Manufacturer:

ABB Oy Motors and Generators P.O. Box 633 Sörnäisten Puistotie 5A FIN - 05101 Vaasa, Finland	ABB Sp. z o.o. 27 Płacydowska Str. PL-95-070 Aleksandrów Łódzki Poland
--	---

This declaration of conformity is issued under the sole responsibility of the manufacturer.
The products of the declaration described above are in conformity with the relevant Union harmonization legislation.

Directive 2014/34/EU
The following harmonized standards are applied in relation to which conformity is declared: EN 60079-0:2013, EN 60079-1:2014*, EN 60079-2:2015, EN 60079-3:2014* and relevant parts of the EN 60054 series of standards.

Directive 2006/125/EC
The motors that are marked as IE2, IE3 or IE4 are in conformity with the requirements set in the Commission Regulation (EC) No. 642/2009 and the amending Regulation (EU) No. 4/2014.

Directive 2011/65/EU
Motors are in conformity with the Directive 2011/65/EU and the amending Annex II to this Directive of the Delegated Directive (EU) 2015/963 of the European Parliament and of the Council on the restriction of the use of certain hazardous substances in electrical and electronic equipment.

Notes:
Motors shall be installed and maintained according to the relevant standards and instructions of ABB Oy, Motors and Generators. When installed in converter supplied applications, additional requirements must be respected regarding the motor as well as the installation as described in the appropriate dedicated addendum. The conformity of the incorporation into a finished product according to the Directive 2006/42/EC shall be established by the commissioning party when a motor is fitted to the machinery.

Notified Bodies (EN8B): LCIE (008E), Av. Du Général Leclerc, 33, 92266 Fontenay-aux-Roses, France, VTT Expert Services Ltd (0537), Otakaari 78, 02044 Espoo, Finland, UL International Demko A/S (0539), Borupvang 5A, 2750 Ballerup, Denmark

Signed for and on behalf of: ABB Oy, Motors and Generators
Place and date of issue: Vaasa, Finland, 2019-09-04
Harri Mykkänen
Vice President

36ZF500930-309L

01

TYPE EXAMINATION CERTIFICATE



Equipment or Protective System intended for use in Potentially Explosive Atmospheres
Directive 2014/34/EU

Type Examination Certificate Number: **DEMKO 18 ATEX 2076X Rev. 6**

Product: **M3GP, M3DP, M3BP, M3LP, M3BN Motors Frame Sizes 71 to 450**

Manufacturer: **ABB Oy, Motors and Generators**

Address: **Strömbergin Puistotie 5A, P.O. Box 633, 65101 VAASA Finland**

This equipment and any acceptable variation thereto is specified in the certificate and the documents therein referred to.

UL International Demko A/S certifies that this product has been found to comply with the Essential Health and Safety Requirements relating to the design and construction of products intended for use in potentially explosive atmospheres given in Annex II to Directive 2014/34/EU of the European Parliament and of the Council, dated 26 February 2014.

The examination and test results are recorded in confidential report no. **478843691.1.1**

Compliance with the Essential Health and Safety Requirements has been assumed by compliance with:

EN 60079-0:2013+A11:2013	IEC 60079-0, 7th Edition
EN 60079-1:2015	EN 60079-1:2014

except in respect of those requirements listed at item 18 of the Schedule.

If the sign "X" is placed after the certificate number, it indicates that the product is subject to the Specific Conditions of Use specified in the schedule to this certificate.

This Type examination certificate relates only to the design of the specified product, and not to specific items of product subsequently manufactured.

The marking of the product shall include the following:



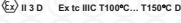

Certification Manager: Jan-Erik Storgaard

Certification Body: UL International Demko A/S, Borupvang 5A, 2750 Ballerup, Denmark
Tel. +45 44 85 65 65, info.dk@ul.com, www.ul.com

UL-IC-F2000-1 - Issue 15.0 Page 1 of 3

02



IECEx Certificate of Conformity

INTERNATIONAL ELECTROTECHNICAL COMMISSION
IECEx Certification Scheme for Explosive Atmospheres

for rules and details of the IECEx Scheme visit www.iecex.com

Certificate No.: IECEx UL 18.0081X	Issue No: 0	Certificate History: Issue No. 0 (2018-08-02)
Status: Current	Page 1 of 4	
Date of Issue: 2019-06-02		
Applicant: ABB Oy, motors and generators Strömbergin Puistotie 5A P.O. Box 633 65101 VAASA Finland		
Equipment: Asynchronous Motors - M3GP, M3DP, M3BP, M3BN, M3LP Motors Frame Sizes 71 to 450		
Optional accessory:		
Type of Protection: Increased Safety "nc", Dust Ignition Protection by Enclosure "n, B"		
Marking: Ex ec IIC T3...T1 Gc Ex tc IIC T100°C...T150°C Dc or Ex tc IIC T100°C...T150°C Dc 40°C to +40°C (71-132 Frame Sizes) 55°C to +40°C (160-450 Frame Sizes)		
Approved for issue on behalf of the IECEx Certification Body:	Lucy Frinders	
Position:	Staff Engineer	
Signature: (for printed version)		
Date:		

1. This certificate and schedule may only be reproduced in full.
2. This certificate is not transferable and remains the property of the issuing body.
3. The Status and authenticity of this certificate may be verified by visiting the Official IECEx Website.

Certificate issued by:



333 Pfingsten Road
Northbrook, IL 60062-2098
United States of America

03

Motors in brief

Dust ignition protection cast iron motors

Motor size		71	80	90	100	112	132	160	180	
Stator	Material	Cast iron, EN-GLJ-150 or better							Cast iron, EN-GJL-200 or better	
	Paint colour shade	Blue, Munsell 8B 4.5/3.25								
	Corrosion class	C3 medium according to ISO/EN 12944-5								
Feet		Cast iron, EN-GLJ-150 or better, integrated with stator							Integrated cast iron feet, for frame sizes 160-250 bolted feet when terminal box on LHS/RHS	
Bearing end shields	Material	Cast iron, EN-GLJ-150 or better							Cast iron, EN-GJL-200 or better	
	Paint colour shade	Blue, Munsell 8B 4.5/3.25								
	Corrosion class	C3 medium according to ISO/EN 12944-5								
Bearings	D-end 2-8 pole	6203-2Z/C3	6204-2Z/C3	6205-2Z/C3	6206-2Z/C3	6206-2Z/C3	6208-2Z/C3	6309/C3	6310/C3	
	N-end 2-8 pole	6202-2Z/C3	6203-2Z/C3	6204-2Z/C3	6205-2Z/C3	6205-2Z/C3	6208-2Z/C3	6209/C3	6209/C3	
Axially-locked bearings	Inner bearing cover	As standard, locked at D-end								
Bearing seal		Gamma ring								
Lubrication		Permanent grease lubrication							Regreasable bearings	
SPM-nipples		Optional							As standard	
Rating plate	Material	Stainless steel								
Terminal box	Frame material	Cast iron, EN-GLJ-150 or better							Cast iron, EN-GJL-200 or better	
	Cover material	Cast iron, EN-GLJ-150 or better							Cast iron, EN-GJL-200 or better	
	Screws	Acid proof steel A4-80								
Connections	Cable entries	2xM16 plugged	2 x M25 plugged		2 x M32 plugged			2 x M40 + 2 x M20 plugged		
	Terminals	6 terminals for connection with cable lugs (not included)								
Fan	Material	Aluminum								
Fan cover	Material	Steel							Hot dip galvanized steel	
	Paint colour shade	Blue, Munsell 8B 4.5/3.25								
	Corrosion class	C3 medium according to ISO/EN 12944-5								
Stator winding	Material	Copper								
	Insulation	Insulation class F								
	Winding protection	3 pcs thermistors								
Rotor winding	Material	Pressure die-cast aluminum								
Balancing		Half key balancing								
Key ways		Closed								
Heating elements	On request	25 W								
Drain holes		Closed								
External earthing bolt		As standard								
Enclosure		IP55 for Ex tc IIIB, IP65 for Ex tc IIIC and Ex tb								
Cooling method		IC 411								

Motors in brief

Dust ignition protection cast iron motors

Motor size		200	225	250	280	315	355	400	
Stator	Material	Cast iron, EN-GJL-200 or better							
	Paint colour shade	Blue, Munsell 8B 4.5/3.25							
	Corrosion class	C3 medium according to ISO/EN 12944-5							
Feet		Integrated cast iron feet, for frame sizes 160-250 bolted feet when terminal box on LHS/RHS				Cast iron, EN-GJL-200 or better, integrated with stator			
Bearing end shields	Material	Cast iron, EN-GJL-200 or better							
	Paint colour shade	Blue, Munsell 8B 4.5/3.25							
	Corrosion class	C3 medium according to ISO/EN 12944-5							
Bearings	D-end	2-pole	6312/C3	6313/C3	6315/C3	6316/C3	6316/C3	6316M/C3	6317/C3
		4-12 -pole	6312/C3	6313/C3	6315/C3	6316/C3	6319/C3	6322/C3	6324/C3
	N-end	2-pole	6210/C3	6212/C3	6213/C3	6316/C3	6319/C3	6316M/C3	6317/C3
		4-12 -pole	6210/C3	6212/C3	6213/C3	6316/C3	6316/C3	6316/C3	6319/C3
Axially-locked bearings	Inner bearing cover	As standard, locked at D-end							
Bearing seal		Gamma ring				V-ring or labyrinth seal			
Lubrication		Regreasable bearings							
SPM-nipples		As standard							
Rating plate	Material	Stainless steel							
Terminal box	Frame material	Cast iron, EN-GJL-200 or better							
	Cover material	Cast iron, EN-GJL-200 or better							
	Cover screws material	Steel 8.8, zinc electroplated and chromated							
Connections	Cable entries	2 x M63 + 2 x M20 plugged				2 x M63 + 2 x M20 plugged		Refer to page 63	
	Terminals	6 terminals for connection with cable lugs (not included)							
Fan	Material	Aluminum							
Fan cover	Material	Hot dip galvanized steel							
	Paint colour shade	Blue, Munsell 8B 4.5/3.25							
	Corrosion class	C3 medium according to ISO/EN 12944-5							
Stator winding	Material	Copper							
	Insulation	Insulation class F							
	Winding protection	3 pcs thermistors							
Rotor winding	Material	Pressure die-cast aluminum							
Balancing		Half key balancing							
Key ways		Closed key way				Open key away			
Heating elements	Optional	25 W	60 W				120 W		
Drain holes		As standard							
External earthing bolt		As standard							
Enclosure		IP55 for Ex tc IIIB, IP65 for Ex tc IIIC and Ex tb							
Cooling method		IC 411							

Motor construction

Dust ignition protection cast iron motors, Ex t

Typical exploded view of cast iron motors, frame size 315

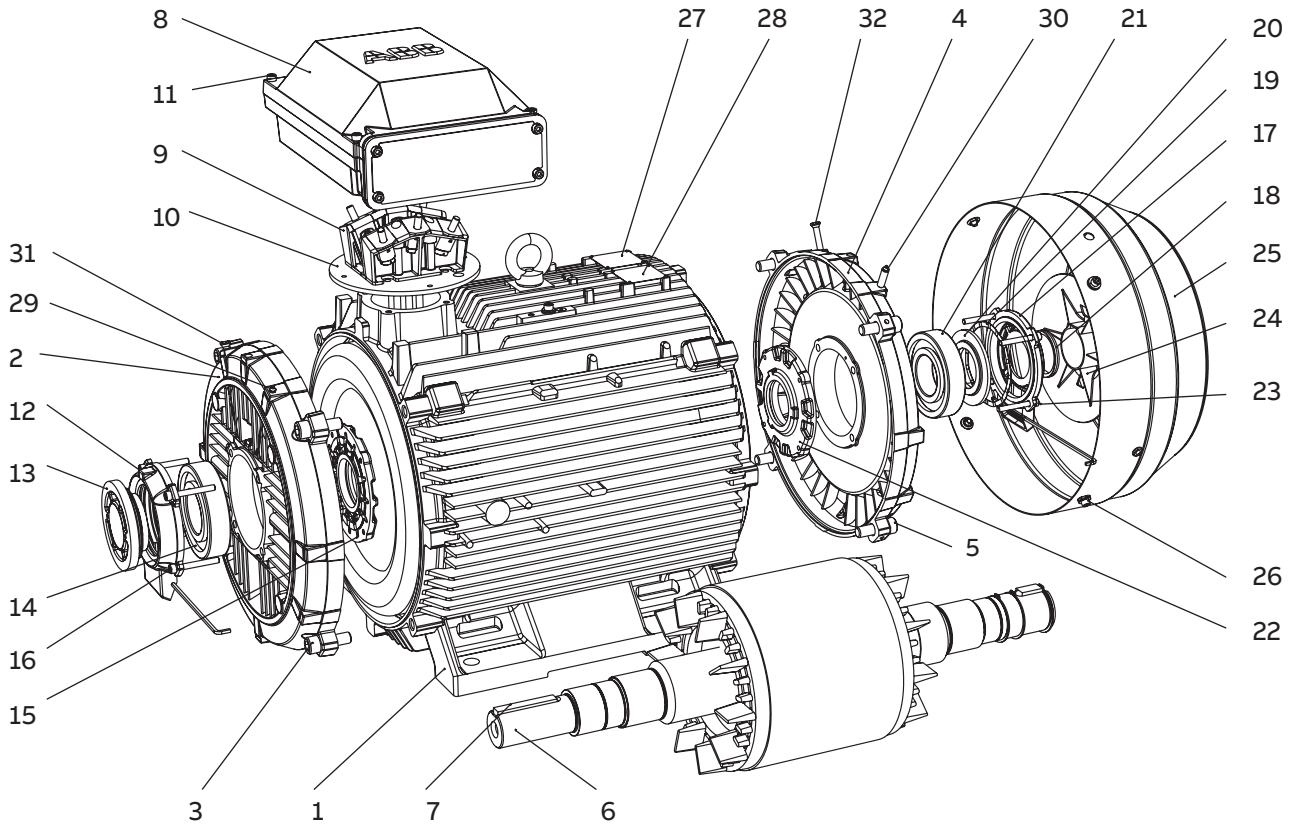

- | | | |
|----------------------------------|---|------------------------------------|
| 1 Stator frame | 12 Outer bearing cover, D-end | 22 Inner bearing cover, N-end |
| 2 Endshield, D-end | 13 Valve disc with labyrinth seal, D-end;
standard in 2-pole motors (V-ring in 4-8 pole) | 23 Screws for bearing cover, N-end |
| 3 Screws for endshield, D-end | 14 Bearing, D-end | 24 Fan |
| 4 Endshield, N-end | 15 Inner bearing cover, D-end | 25 Fan cover |
| 5 Screws for endshield, N-end | 16 Screws for bearing cover, D-end | 26 Screws for fan cover |
| 6 Rotor with shaft | 17 Outer bearing cover, N-end | 27 Rating plate |
| 7 Key, D-end | 18 Seal, N-end | 28 Regreasing plate |
| 8 Terminal box | 19 Wave spring | 29 Grease nipple, D-end |
| 9 Terminal board | 20 Valve disc, N-end | 30 Grease nipple, N-end |
| 10 Intermediate flange | 21 Bearing, N-end | 31 SPM nipple, D-end |
| 11 Screws for terminal box cover | | 32 SPM nipple, N-end |

Dust ignition protection aluminum motors

78	Ordering information
79	Rating plates
80	Technical data IE3
80	3000 r/min motors
82	1500 r/min motors
84	1000 r/min motors
86	1000 r/min motors
87	Technical data IE2
87	3000 r/min motors
89	1500 r/min motors
91	1000 r/min motors
93	750 r/min motors
95	Variant codes
99	Mechanical design
99	Motor frame and drain holes
100	Bearings
105	Terminal box
107	Dimension drawings
109	Motors in brief
109	Motor sizes 90 - 280

Ordering information

Explanation of the product code

Motor type	Motor size	Product code	Mounting arrangement code, Voltage and frequency code, Generation code	Variant codes
M3AA	160MLA	3GAA 162 410	- ADG	340, etc.
		1 2 3 4 5 6 7 8 9 10 11 12 13 14		

Positions 1 to 4

3GQP: Totally enclosed fan cooled squirrel cage motor with cast iron frame, dust ignition proof

3GAA: Totally enclosed fan cooled squirrel cage motor with aluminum frame, dust ignition proof

Positions 5 and 6

IEC size

63	63
71	71
08:	80
09:	90
10:	100
11:	112
13:	132
16:	160
18:	180
20:	200
22:	225
25:	250
28:	280
31:	315
35:	355
40:	400
45:	450

Position 7

Speed (Pole pairs)

1:	2 poles
2:	4 poles
3:	6 poles
4:	8 poles
5:	10 poles

Positions 8 to 10

Serial number

Position 11

- (Dash)

Position 12

Mounting arrangement

A:	Foot-mounted, top-mounted terminal box
R:	Foot-mounted, terminal box RHS seen from D-end
L:	Foot-mounted, terminal box LHS seen from D-end
B:	Flange-mounted, large flange
C:	Flange-mounted, small flange (sizes 71 to 112)
H:	Foot- and flange-mounted, terminal box top-mounted
J:	Foot- and flange-mounted, small flange with tapped holes
S:	Foot- and flange-mounted, terminal box RHS seen from D-end
T:	Foot- and flange-mounted, terminal box LHS seen from D-end
V:	Flange-mounted, special flange
F:	Foot- and flange-mounted. Special flange

Position 13

Voltage and frequency code

Single-speed motors

B:	380 VΔ 50 Hz
D:	400 VΔ, 415 VΔ, 690 VY 50 Hz
E:	500 VΔ 50 Hz
F:	500 VY 50 Hz
S:	230 VΔ, 400 VY, 415 VY 50 Hz
T:	660 VΔ 50 Hz
U:	690 VΔ 50 Hz
X:	Other rated voltage, connection or frequency, 690 V maximum

Position 14

Generation code

G, H... The product code must be, if needed, followed by variant codes.

Explanation of technical data pages:

The two bullets in the product code indicate choice of mounting arrangements, voltage and frequency code (see ordering information page).

Efficiency values are given according to IEC 60034-2-1; 2007. Please note that the values are not comparable without knowing the testing method. ABB has calculated the efficiency values according to indirect method, stray load losses (additional losses) determined from measuring.

I_s / I_N = Starting current
 T_l / T_N = Locked rotor torque
 T_b / T_N = Pull-out torque

Rating plates

01 Sample rating plate for aluminum Increased-safety Ex tc III B T125C Dc, motor in frame size 160.

The rating plates are in table form giving values for speed, output, current and power factor at different voltages, there are two rows available for different voltages, usually is the corresponding voltages for star and delta connection stamped. Other voltage and frequency combinations are possible and can be ordered with variant codes 002 or 209. Please refer to the variant code section.

The following information will be shown on the motor rating plate:

- Lowest nominal efficiency at 100%, 75% and 50% rated load
- Efficiency level
- Year of manufacture
- Type of protection
- Apparatus group
- Temperature class
- Identification number of the certification body
- Certificate number ATEX and IECEx (if available)

		ABB Oy, IEC LV Motors Strömbergin puistotie 5 A 65320 Vaasa, Finland				IEC60034-1			
3~ Motor		M3AA 160MLB 6 IMB3/IM1001		2022					
Ex tc III B T125°C Dc		2044835-30		No. 3G1F2205783463		Ins. cl. F		IP 55	
V	Hz	kW	r/min	A	cos φ	Duty			
690	Y	50	11	979	13.6	0.74	S1		
400	D	50	11	979	23.5	0.74	S1		
660	Y	50	11	976	13.8	0.77	S1		
380	D	50	11	976	23.8	0.77	S1		
415	D	50	11	981	23.6	0.71	S1		
460	D	60	11	1183	20.6	0.73	S1		
IE3-50Hz-90.3%(100%)-90.4%(75%)-89.2%(50%) / IE3-60Hz-91.7%(100%)									
Product code		3GAA163420-ADK +VC							
EESF 20 ATEX 073X / IECEx EESF 20.0036X		Manual: 3GZF500730-47							
6309-2Z/C3		6209-2Z/C3		139 kg					

01

Technical data for Ex t IIIB/IIIC IE3 aluminum motors, 3000 r/min

IP 55 - IC 411 - Insulation class F, temperature rise class B
IE3 efficiency class according to IEC 60034-30-1; 2014

Output kW	Motor type	Product code	Speed r/min	Efficiency IEC 60034-30-1; 2014			Power factor Cosφ	Current		Torque		Moment of inertia J = 1/4 GD ² kgm ²	Weight kg	Sound pressure Level L _{PA} dB	
				Full load 100%	3/4 load 75%	1/2 load 50%		I _N A	I _s /I _N	T _N Nm	T _i /T _N				T _b /T _N
3000 r/min = 2 poles				400 V 50 Hz				CENELEC							
1.5	M3AA 90LB 2	3GAA091520-...K	2906	86.1	86.6	86.5	0.89	2.8	7.9	4.9	2.3	3.3	0.0027	17	60
2.2	M3AA 90LC 2	3GAA091530-...K	2900	87.4	88.8	88.9	0.89	4.0	8.3	7.2	2.9	3.5	0.0032	20	60
3	M3AA 100LC 2	3GAA101530-...K	2896	87.9	88.9	88.7	0.90	5.4	8.4	9.8	3.2	3.9	0.0057	28	62
4	M3AA 112MB 2	3GAA111320-...K	2888	88.5	89.8	90.0	0.91	7.1	8.4	13.2	3.2	4.0	0.0104	38	68
5.5	M3AA 132SB 2	3GAA131120-...K	2901	89.3	90.0	90.2	0.91	9.7	7.9	18.1	2.3	3.4	0.0154	58	68
7.5	M3AA 132SC 2	3GAA131130-...K	2909	90.7	91.8	92.0	0.90	13.1	8.3	24.6	3.0	3.9	0.0173	63	70
11	M3AA 160MLA 2	3GAA161410-...K	2943	91.2	92.0	91.6	0.91	19.1	7.2	35.6	2.6	3.6	0.057	106	69
15	M3AA 160MLB 2	3GAA161420-...K	2947	91.9	92.2	91.8	0.88	26.7	8.2	48.6	3.2	4.2	0.063	123	69
18.5	M3AA 160MLC 2	3GAA161430-...K	2949	92.4	93.0	92.6	0.90	32.1	9.0	59.9	3.3	3.9	0.076	137	73
22	M3AA 180MLA 2	3GAA181410-...K	2956	92.7	93.1	92.7	0.90	37.7	7.8	71.0	3.0	3.8	0.11	176	73
30	M3AA 200MLA 2	3GAA201410-...K	2962	93.3	93.5	92.8	0.87	53.2	7.6	96.8	3.1	3.8	0.159	225	72
37	M3AA 200MLB 2	3GAA201420-...K	2961	93.7	94.1	93.8	0.88	64.4	8.2	119	3.0	3.3	0.196	241	72
45	M3AA 225SMA 2	3GAA221210-...K	2968	94.0	94.0	93.0	0.87	79.6	7.3	145	3.2	3.1	0.296	326	76
55	M3AA 250SMA 2	3GAA251210-...K	2968	94.3	93.7	93.6	0.89	94.8	6.8	177	2.4	3.0	0.426	351	76
75	M3AA 280SMA 2	3GAA281210-...K	2971	94.7	95.1	94.8	0.90	127	7.9	241	2.8	3.3	0.644	412	81
90	M3AA 280SMB 2	3GAA281220-...K	2974	95.0	95.2	94.7	0.89	154	9.7	289	3.3	3.6	0.6	420	81.0

Equipment protection level and equipment group subdivision must be selected when ordering by choosing appropriate variant code:

Sizes 90-132

334 Ex t, Dust group III B T125C Db, IP6X (non-conductive dust) acc. IEC/EN60079-31

335 Ex t, Dust group III B T125C Dc, IP5X (non-conductive dust) acc. IEC/EN60079-31

336 Ex t, Dust group III C T125 Db, IP6X (conductive dust) acc. IEC/EN60079-31

337 Ex t, Dust group III C T125 Dc, IP6X (conductive dust) acc. IEC/EN60079-31

Sizes 160-280

340 Ex t, Dust group III B T125C Dc (non-conductive dust) with manufacturers declaration

Technical data for Ex t IIIB/IIIC IE3 aluminum motors, 3000 r/min

IP 55 - IC 411 - Insulation class F, temperature rise class B
IE3 efficiency class according to IEC 60034-30-1; 2014

Output kW	Motor type	Product code	Speed r/min	Efficiency IEC 60034-30-1; 2014			Power factor Cosφ	Current			Torque		Moment of inertia J = 1/4 GD ² kgm ²	Weight kg	Sound pressure Level L _{PA} dB
				Full load 100%	3/4 load 75%	1/2 load 50%		I _N A	I _s /I _N	T _N Nm	T _i /T _N	T _b /T _N			
3000 r/min = 2 poles				400 V 50 Hz				High-output							
22	M3AA 160MLD 2	3GAA161440-...K	2944	92.7	93.5	93.4	0.90	38.0	8.4	71	3.2	3.7	0.071	131	74
30	M3AA 180MLB 2	3GAA181420-...K	2957	93.3	94.0	93.9	0.88	52.7	8.7	97	3.0	3.8	0.104	162	74
37	¹⁾ M3AA 180MLC 2	3GAA181430-...K	2950	93.7	94.2	94.2	0.86	66.0	8.4	120	3.4	4.4	0.117	176	74
45	M3AA 200MLC 2	3GAA201430-...K	2956	94.0	94.6	94.8	0.89	77.2	7.8	145	2.9	3.3	0.216	250	77
55	M3AA 225SMB 2	3GAA221220-...K	2964	94.3	94.4	93.9	0.86	97.4	7.2	177	3.1	3.2	0.2991	288	79
72	¹⁾ M3AA 225SMC 2	3GAA221230-...K	2966	94.7	95.0	94.7	0.86	132	7.6	242	3.1	3.1	0.3615	328	79
75	¹⁾ M3AA 250SMB 2	3GAA251220-...K	2971	94.7	95.1	94.8	0.90	127	7.9	241	2.8	3.3	0.644	405	81
90	¹⁾ M3AA 250SMC 2	3GAA251230-...K	2975	95.0	95.2	94.6	0.87	156	8.5	289	2.9	3.6	0.5141	414	81

¹⁾ Temperature rise class F.

Equipment protection level and equipment group subdivision must be selected when ordering by choosing appropriate variant code:

Sizes 90-132

334 Ex t, Dust group III B T125C Db, IP6X (non-conductive dust) acc. IEC/EN60079-31

335 Ex t, Dust group III B T125C Dc, IP5X (non-conductive dust) acc. IEC/EN60079-31

336 Ex t, Dust group III C T125 Db, IP6X (conductive dust) acc. IEC/EN60079-31

337 Ex t, Dust group III C T125 Dc, IP6X (conductive dust) acc. IEC/EN60079-31

Sizes 160-280

340 Ex t, Dust group III B T125C Dc (non-conductive dust) with manufacturers declaration

Technical data for Ex t IIIB/IIIC IE3 aluminum motors, 1500 r/min

IP 55 - IC 411 - Insulation class F, temperature rise class B
IE3 efficiency class according to IEC 60034-30-1; 2014

Output kW	Motor type	Product code	Speed r/min	Efficiency IEC 60034-30-1; 2014			Power factor Cosφ	Current			Torque		Moment of inertia J = 1/4 GD ² kgm ²	Weight kg	Sound pressure Level L _{PA} dB
				Full load 100%	3/4 load 75%	1/2 load 50%		I _N A	I _s /I _N	T _N Nm	T _i /T _N	T _b /T _N			
1500 r/min = 4 poles				400 V 50 Hz				CENELEC							
1.1	M3AA 90LC 4	3GAA092530-...K	1442	85.6	85.1	83.4	0.80	2.3	7.9	7.2	3.3	3.9	0.0055	19	56
1.5	M3AA 90LD 4	3GAA092540-...K	1439	85.3	84.7	82.8	0.78	3.2	8.2	9.9	3.5	4.0	0.0055	19	51
2.2	M3AA 100LE 4	3GAA102550-...K	1454	89.1	89.5	88.6	0.83	4.3	8.9	14.5	3.1	4.1	0.0144	36	54
3	M3AA 100LF 4	3GAA102560-...K	1452	88.8	89.2	88.3	0.83	5.9	9.0	19.7	3.5	4.2	0.0144	36	54
4	M3AA 112MB 4	3GAA112320-...K	1451	88.6	89.4	89.0	0.77	8.6	7.6	26.3	3.1	4.1	0.018	44	59
5.5	M3AA 132MB 4	3GAA132320-...K	1464	89.6	90.2	89.5	0.78	11.4	7.0	35.9	2.8	3.9	0.0295	68	70
7.5	M3AA 132MC 4	3GAA132330-...K	1464	90.6	91.0	90.9	0.81	14.7	7.7	48.9	2.5	3.6	0.0414	68	64
11	M3AA 160MLA 4	3GAA162410-...K	1477	91.4	91.8	91.1	0.82	21.1	7.6	71.3	2.6	3.3	0.11	126	61
15	M3AA 160MLB 4	3GAA162420-...K	1474	92.1	92.2	91.3	0.81	29.0	7.8	97.2	3.0	3.6	0.135	140	61
18.5	M3AA 180MLA 4	3GAA182410-...K	1481	92.6	93.2	92.9	0.83	34.9	7.2	119	2.8	3.0	0.219	177	60
22	M3AA 180MLB 4	3GAA182420-...K	1480	93.3	94.1	94.1	0.82	41.5	8.2	141	2.8	3.1	0.217	176	62
30	M3AA 200MLA 4	3GAA202410-...K	1481	93.6	93.9	93.4	0.84	55.0	7.5	193	2.7	3.2	0.385	246	63
37	M3AA 225SMA 4	3GAA222210-...K	1481	93.9	94.1	93.4	0.82	69.8	8.0	235	3.3	3.5	0.427	315	67
45	M3AA 225SMB 4	3GAA222220-...K	1482	94.2	94.4	94.0	0.84	82.3	8.0	290	3.1	3.5	0.525	316	66
55	M3AA 250SMA 4	3GAA252210-...K	1485	95.4	95.9	95.7	0.85	97.8	7.9	353	3.0	3.3	0.933	376	67
75	M3AA 280SMA 4	3GAA282210-...K	1482	95.0	95.5	95.3	0.82	138	7.9	483	3.6	3.8	0.941	409	73

Equipment protection level and equipment group subdivision must be selected when ordering by choosing appropriate variant code:

Sizes 90-132

334 Ex t, Dust group III B T125C Db, IP6X (non-conductive dust) acc. IEC/EN60079-31

335 Ex t, Dust group III B T125C Dc, IP5X (non-conductive dust) acc. IEC/EN60079-31

336 Ex t, Dust group III C T125 Db, IP6X (conductive dust) acc. IEC/EN60079-31

337 Ex t, Dust group III C T125 Dc, IP6X (conductive dust) acc. IEC/EN60079-31

Sizes 160-280

340 Ex t, Dust group III B T125C Dc (non-conductive dust) with manufacturers declaration

Technical data for Ex t IIIB/IIIC IE3 aluminum motors, 1500 r/min

IP 55 - IC 411 - Insulation class F, temperature rise class B
IE3 efficiency class according to IEC 60034-30-1; 2014

Output kW	Motor type	Product code	Speed r/min	Efficiency IEC 60034-30-1; 2014			Power factor Cosφ	Current		Torque		Moment of inertia J = 1/4 GD ² kgm ²	Weight kg	Sound pressure Level L _{PA} dB	
				Full load 100%	3/4 load 75%	1/2 load 50%		I _N A	I _s /I _N	T _N Nm	T _i /T _N				T _b /T _N
1500 r/min = 4 poles				400 V 50 Hz				High-output							
18.5	M3AA 160MLC 4	3GAA162430-...K	1476	92.6	93.1	92.7	0.77	37.2	8.3	120	3.3	3.6	0.12	135	67
30	M3AA 180MLC 4	3GAA182430-...K	1482.4	93.4	93.3	92.3	0.77	56.5	8.2	180	3.0	3.6	0.19	176	62
37 ¹⁾	M3AA 200MLB 4	3GAA202420-...K	1482	93.9	94.1	93.7	0.82	69.3	7.8	238	3.1	3.3	0.36	244	68
51	M3AA 225SMC 4	3GAA222230-...K	1481	94.4	94.5	93.9	0.81	103	9.3	328	3.4	3.7	0.53	318	71
75	M3AA 250SMB 4	3GAA252220-...K	1482	95.0	95.4	95.0	0.84	135	7.9	483	3.3	3.5	0.94	389	73

¹⁾ Temperature rise class F.

Equipment protection level and equipment group subdivision must be selected when ordering by choosing appropriate variant code:
Sizes 90-132

334 Ex t, Dust group III B T125C Db, IP6X (non-conductive dust) acc. IEC/EN60079-31

335 Ex t, Dust group III B T125C Dc, IP5X (non-conductive dust) acc. IEC/EN60079-31

336 Ex t, Dust group III C T125 Db, IP6X (conductive dust) acc. IEC/EN60079-31

337 Ex t, Dust group III C T125 Dc, IP6X (conductive dust) acc. IEC/EN60079-31

Sizes 160-280

340 Ex t, Dust group III B T125C Dc (non-conductive dust) with manufacturers declaration

Technical data for Ex t IIIB/IIIC IE3 aluminum motors, 1000 r/min

IP 55 - IC 411 - Insulation class F, temperature rise class B
IE3 efficiency class according to IEC 60034-30-1; 2014

Output kW	Motor type	Product code	Speed r/min	Efficiency IEC 60034-30-1; 2014			Power factor Cosφ	Current		Torque		Moment of inertia J = 1/4 GD ² kgm ²	Weight kg	Sound pressure Level L _{PA} dB	
				Full load 100%	3/4 load 75%	1/2 load 50%		I _N A	I _s /I _N	T _N Nm	T _i /T _N				T _b /T _N
1000 r/min = 6 poles				400 V 50 Hz				CENELEC							
0.75	M3AA 90LD 6	3GAA093540-...K	937	80.3	80.5	79.5	0.76	1.78	4.6	7.6	2.1	2.3	0.0055	19	55
1.1	M3AA 100LE 6	3GAA103550-...K	963	84.0	85.0	84.0	0.69	2.6	5.6	10.9	2.3	3.1	0.0138	35	49
1.5	M3AA 100LF 6	3GAA103560-...K	969	85.7	85.9	84.2	0.65	3.7	7.0	14.7	3.3	4.1	0.0138	35	49
2.2	M3AA 112MC 6	3GAA113330-...K	967	87.2	87.9	87.1	0.69	5.2	6.5	21.7	2.4	3.5	0.0187	43	68
3	M3AA 132MC 6	3GAA133330-...K	978	88.5	88.8	87.7	0.69	7.0	6.2	29.2	2.0	3.0	0.0402	66	61
4	M3AA 132MD 6	3GAA133340-...K	973	88.5	89.3	89.1	0.72	9.1	5.6	39.2	1.9	2.7	0.0402	67	61
5.5	M3AA 132ME 6	3GAA133350-...K	973	89.5	90.2	89.6	0.74	12.0	5.8	53.9	2.0	2.9	0.039	63	61
7.5	M3AA 160MLA 6	3GAA163410-...K	980	90.8	91.5	91.0	0.78	15.2	7.9	73.0	1.7	3.3	0.114	125	59
11	M3AA 160MLB 6	3GAA163420-...K	979	91.2	91.8	91.1	0.74	23.5	8.5	107	2.2	3.9	0.131	139	59
15	M3AA 180MLA 6	3GAA183410-...K	987	92.2	92.5	91.5	0.77	30.4	5.5	146	1.7	2.7	0.225	175	59
18.5	M3AA 200MLA 6	3GAA203410-...K	990	92.8	93.2	92.6	0.77	37.3	7.5	178	2.6	3.2	0.448	218	63
22	M3AA 200MLB 6	3GAA203420-...K	990	93.3	93.7	93.1	0.79	43.0	7.8	212	2.6	3.2	0.531	245	63
30	M3AA 225SMA 6	3GAA223210-...K	989	94.1	94.7	94.5	0.81	56.8	7.9	289	2.8	3.1	0.813	310	63
37	M3AA 250SMA 6	3GAA253210-...K	991	94.4	94.9	94.7	0.83	68.0	7.7	356	2.7	2.9	1.49	367	63
45	M3AA 280SMA 6	3GAA283210-...K	991	93.7	93.8	93.1	0.79	87.3	8.0	433	3.1	3.2	1.33	398	68

Equipment protection level and equipment group subdivision must be selected when ordering by choosing appropriate variant code:

Sizes 90-132

334 Ex t, Dust group III B T125C Db, IP6X (non-conductive dust) acc. IEC/EN60079-31

335 Ex t, Dust group III B T125C Dc, IP5X (non-conductive dust) acc. IEC/EN60079-31

336 Ex t, Dust group III C T125 Db, IP6X (conductive dust) acc. IEC/EN60079-31

337 Ex t, Dust group III C T125 Dc, IP6X (conductive dust) acc. IEC/EN60079-31

Sizes 160-280

340 Ex t, Dust group III B T125C Dc (non-conductive dust) with manufacturers declaration

Technical data for Ex t IIIB/IIIC IE3 aluminum motors, 1000 r/min

IP 55 - IC 411 - Insulation class F, temperature rise class B
IE3 efficiency class according to IEC 60034-30-1; 2014

Output kW	Motor type	Product code	Speed r/min	Efficiency IEC 60034-30-1; 2014			Power factor Cosφ	Current		Torque		Moment of inertia J = 1/4 GD ² kgm ²	Weight kg	Sound pressure Level L _{PA} dB	
				Full load 100%	3/4 load 75%	1/2 load 50%		I _N A	I _s /I _N	T _N Nm	T _i /T _N				T _b /T _N
1000 r/min = 6 poles				400 V 50 Hz				High-output							
18.5	M3AA 180MLB 6	3GAA183420-...K	980	91.7	92.1	91.5	0.72	40.3	6.8	180	2.3	3.2	0.191	168	65
37	M3AA 225SMB 6	3GAA223220-...K	985	93.3	93.8	93.5	0.80	71.5	7.0	359	2.7	3.0	0.813	307	68
45	M3AA 250SMB 6	3GAA253220-...K	991	93.7	93.8	93.1	0.79	87.3	8.0	433	3.1	3.2	1.33	389	68
55	M3AA 250SMC 6	3GAA253230-...K	989	94.1	94.8	94.6	0.80	105	7.1	531	3.0	3.1	1.49	390	68

Equipment protection level and equipment group subdivision must be selected when ordering by choosing appropriate variant code:

Sizes 90-132

334 Ex t, Dust group III B T125C Db, IP6X (non-conductive dust) acc. IEC/EN60079-31

335 Ex t, Dust group III B T125C Dc, IP5X (non-conductive dust) acc. IEC/EN60079-31

336 Ex t, Dust group III C T125 Db, IP6X (conductive dust) acc. IEC/EN60079-31

337 Ex t, Dust group III C T125 Dc, IP6X (conductive dust) acc. IEC/EN60079-31

Sizes 160-280

340 Ex t, Dust group III B T125C Dc (non-conductive dust) with manufacturers declaration

Technical data for Ex t IIIB/IIIC IE3 aluminum motors, 750 r/min

IP 55 - IC 411 - Insulation class F, temperature rise class B
IE3 efficiency class according to IEC 60034-30-1; 2014

Output kW	Motor type	Product code	Speed r/min	Efficiency IEC 60034-30-1; 2014			Power factor Cosφ	Current			Torque		Moment of inertia J = 1/4 GD ² kgm ²	Weight kg	Sound pressure Level L _{PA} dB
				Full load 100%	3/4 load 75%	1/2 load 50%		I _N A	I _s /I _N	T _N Nm	T _i /T _N	T _b /T _N			
750 r/min = 8 poles				400 V 50 Hz				CENELEC							
1.1	M3AA 100LD 8	3GAA104540-...K	703	77.7	77.7	74.7	0.65	3.1	4.4	14.9	2.7	2.9	0.0128	33	53
1.5	M3AA 112MC 8	3GAA114330-...K	717	79.7	80.1	78.8	0.62	4.1	4.3	19.9	1.8	2.6	0.0194	43	55
2.2	M3AA 132SA 8	3GAA134110-...K	725	81.9	82.3	80.2	0.64	5.8	5.2	28.9	2.0	3.0	0.0291	51	57
3	M3AA 132MA 8	3GAA134310-...K	723	83.5	84.1	82.8	0.66	7.5	4.8	39.6	1.8	2.8	0.0375	60	57
4	M3AA 160MLA 8	3GAA164410-...K	734	84.8	85.1	83.2	0.65	10.3	4.5	52.0	1.8	2.3	0.091	94	59
5.5	M3AA 160MLB 8	3GAA164420-...K	732	86.2	87.1	86.1	0.69	13.0	5.0	71.7	2.0	2.4	0.091	96	59
7.5	M3AA 160MLC 8	3GAA164430-...K	733	87.3	88.2	87.2	0.69	17.6	5.1	97.7	2.0	2.4	0.12	120	59
11	M3AA 180MLA 8	3GAA184410-...K	731	88.6	89.2	88.4	0.70	25.3	5.0	144	2.1	2.1	0.2	161	59
15	M3AA 200MLA 8	3GAA204410-...K	737	89.6	90.5	90.1	0.74	32.5	5.2	194	2.1	2.4	0.45	217	60
18.5	M3AA 225SMA 8	3GAA224210-...K	736	90.1	90.8	90.2	0.74	39.8	5.2	240	2.0	2.3	0.669	266	63
22	M3AA 225SMB 8	3GAA224220-...K	736	90.6	91.6	91.5	0.73	47.5	5.3	285	2.3	2.5	0.722	279	63
30	M3AA 250SMA 8	3GAA254210-...K	741	91.3	91.7	91.0	0.71	67.0	5.6	386	2.7	2.7	1.4	340	63

Equipment protection level and equipment group subdivision must be selected when ordering by choosing appropriate variant code:

Sizes 90-132

334 Ex t, Dust group III B T125C Db, IP6X (non-conductive dust) acc. IEC/EN60079-31

335 Ex t, Dust group III B T125C Dc, IP5X (non-conductive dust) acc. IEC/EN60079-31

336 Ex t, Dust group III C T125 Db, IP6X (conductive dust) acc. IEC/EN60079-31

337 Ex t, Dust group III C T125 Dc, IP6X (conductive dust) acc. IEC/EN60079-31

Sizes 160-280

340 Ex t, Dust group III B T125C Dc (non-conductive dust) with manufacturers declaration

Technical data for Ex t IIIB/IIIC IE2 aluminum motors, 3000 r/min

IP 55 - IC 411 - Insulation class F, temperature rise class B
IE2 efficiency class according to IEC 60034-30-1; 2014

Output kW	Motor type	Product code	Speed r/min	Efficiency IEC 60034-30-1; 2014			Power factor Cosφ	Current			Torque		Moment of inertia J = 1/4 GD ² kgm ²	Weight kg	Sound pressure Level L _{PA} dB
				Full load 100%	3/4 load 75%	1/2 load 50%		I _N A	I _s /I _N	T _N Nm	T _i /T _N	T _b /T _N			
3000 r/min = 2 poles				400 V 50 Hz				CENELEC							
1.5	M3AA 90L 2	3GAA091500-...E	2900	84.1	85.0	83.5	0.86	2.9	7.6	4.9	2.5	3.3	0.0024	16	60
2.2	M3AA 90LB 2	3GAA091520-...E	2870	84.6	85.7	85.0	0.86	4.4	6.9	7.3	2.8	3.2	0.0027	18	63
3	M3AA 100LB 2	3GAA101520-...E	2920	86.4	86.1	84.0	0.86	5.8	9.3	9.8	3.3	3.9	0.005	25	62
4	M3AA 112MB 2	3GAA111320-...E	2885	86.1	87.0	88.0	0.88	7.6	7.6	13.2	2.5	2.8	0.0062	30	68
5.5	M3AA 132SB 2	3GAA131120-...E	2915	88.0	88.2	86.9	0.82	11.0	7.9	18.0	2.6	3.6	0.016	52	73
7.5	M3AA 132SC 2	3GAA131130-...E	2915	88.5	89.2	88.6	0.88	13.6	7.6	24.5	2.2	3.2	0.022	52	73
11	M3AA 160MLA 2	3GAA161410-...G	2938	90.6	91.5	91.1	0.90	19.2	7.5	35.7	2.4	3.1	0.044	91	69
15	M3AA 160MLB 2	3GAA161420-...G	2934	91.5	92.5	92.2	0.90	26.0	7.5	48.8	2.5	3.3	0.053	105	69
18.5	M3AA 160MLC 2	3GAA161430-...G	2932	92.0	93.1	93.1	0.92	31.5	7.5	60.2	2.9	3.4	0.063	123	69
22	M3AA 180MLA 2	3GAA181410-...G	2952	92.2	92.8	92.2	0.87	39.5	7.7	71.1	2.8	3.3	0.076	132	69
30	¹⁾ M3AA 200MLA 2	3GAA201410-...G	2956	93.1	93.5	92.8	0.90	51.4	7.7	96.9	2.7	3.1	0.178	210	72
37	M3AA 200MLB 2	3GAA201420-...G	2959	93.4	93.7	92.9	0.90	63.5	8.2	119	3.0	3.3	0.196	225	72
45	M3AA 225SMA 2	3GAA221210-...G	2961	93.6	93.9	93.1	0.88	78.8	6.7	145	2.5	2.5	0.244	263	74
55	M3AA 250SMA 2	3GAA251210-...G	2967	94.1	94.4	93.8	0.88	95.8	6.8	177	2.2	2.7	0.507	304	75
75	¹⁾ M3AA 280SMA 2	3GAA281210-...G	2968	94.4	94.7	94.2	0.89	128	7.1	241	2.5	2.8	0.583	389	75
79	¹⁾ M3AA 280SMB 2	3GAA281220-...G	2974	94.9	94.7	93.9	0.88	138	8.8	253	3.0	3.6	0.644	425	75

¹⁾ Temperature rise class F.

Equipment protection level and equipment group subdivision must be selected when ordering by choosing appropriate variant code:

Sizes 90-132

334 Ex t, Dust group III B T125C Db, IP6X (non-conductive dust) acc. IEC/EN60079-31

335 Ex t, Dust group III B T125C Dc, IP5X (non-conductive dust) acc. IEC/EN60079-31

336 Ex t, Dust group III C T125 Db, IP6X (conductive dust) acc. IEC/EN60079-31

337 Ex t, Dust group III C T125 Dc, IP6X (conductive dust) acc. IEC/EN60079-31

Sizes 160-280

340 Ex t, Dust group III B T125C Dc (non-conductive dust) with manufacturers declaration

Technical data for Ex t IIIB/IIIC IE2 aluminum motors, 3000 r/min

IP 55 - IC 411 - Insulation class F, temperature rise class B
IE2 efficiency class according to IEC 60034-30-1; 2014

Output kW	Motor type	Product code	Speed r/min	Efficiency IEC 60034-30-1; 2014			Power factor Cosφ	Current		Torque		Moment of inertia J = 1/4 GD ² kgm ²	Weight kg	Sound pressure Level L _{PA} dB	
				Full load 100%	3/4 load 75%	1/2 load 50%		I _N A	I _s /I _N	T _N Nm	T _i /T _N				T _b /T _N
3000 r/min = 2 poles				400 V 50 Hz				High-output							
22	M3AA 160MLD 2	3GAA161440-...G	2933	91.7	92.8	92.8	0.90	38.0	8.1	71.6	3.2	3.6	0.063	123	69
27	M3AA 160MLE 2	3GAA161450-...G	2939	92.2	93.1	93.1	0.90	46.4	8.8	87.7	3.4	3.8	0.072	145	69
30	¹⁾ M3AA 180MLB 2	3GAA181420-...G	2950	92.7	93.5	93.3	0.88	53.0	7.9	97.1	2.8	3.3	0.092	149	69
45	¹⁾ M3AA 200MLC 2	3GAA201430-...G	2957	93.3	93.8	93.2	0.90	78.2	8.1	145	3.1	3.3	0.196	225	72
50	¹⁾ M3AA 200MLD 2	3GAA201440-...G	2953	93.9	94.1	93.4	0.90	88.6	8.5	161	3.2	3.6	0.217	241	72
55	M3AA 225SMB 2	3GAA221220-...G	2961	93.9	94.3	93.6	0.88	96.0	6.5	177	2.4	2.5	0.274	286	74
67	¹⁾ M3AA 225SMC 2	3GAA221230-...G	2972	94.4	94.2	93.0	0.82	127	8.2	215	3.6	3.5	0.309	312	74
73	¹⁾ M3AA 225SMD 2	3GAA221240-...G	2967	94.4	94.4	93.5	0.86	132	7.9	234	3.3	3.1	0.329	317	74
75	¹⁾ M3AA 250SMB 2	3GAA251220-...G	2970	94.5	94.8	94.3	0.89	128	7.6	241	2.8	3.1	0.583	351	75
77	¹⁾ M3AA 225SMD 2	3GAA221240-...G	2965	94.4	94.4	93.7	0.87	137	7.5	247	3.1	2.9	0.329	317	74
79	¹⁾ M3AA 250SMC 2	3GAA251230-...G	2974	95.0	94.9	94.1	0.88	138	8.6	253	2.8	3.5	0.644	386	75

¹⁾ Temperature rise class F.

Equipment protection level and equipment group subdivision must be selected when ordering by choosing appropriate variant code:

Sizes 90-132

334 Ex t, Dust group III B T125C Db, IP6X (non-conductive dust) acc. IEC/EN60079-31

335 Ex t, Dust group III B T125C Dc, IP5X (non-conductive dust) acc. IEC/EN60079-31

336 Ex t, Dust group III C T125 Db, IP6X (conductive dust) acc. IEC/EN60079-31

337 Ex t, Dust group III C T125 Dc, IP6X (conductive dust) acc. IEC/EN60079-31

Sizes 160-280

340 Ex t, Dust group III B T125C Dc (non-conductive dust) with manufacturers declaration

Technical data for Ex t IIIB/IIIC IE2 aluminum motors, 1500 r/min

IP 55 - IC 411 - Insulation class F, temperature rise class B
IE2 efficiency class according to IEC 60034-30-1; 2014

Output kW	Motor type	Product code	Speed r/min	Efficiency IEC 60034-30-1; 2014			Power factor Cosφ	Current		Torque		Moment of inertia J = 1/4 GD ² kgm ²	Weight kg	Sound pressure Level L _{PA} dB	
				Full load 100%	3/4 load 75%	1/2 load 50%		I _N A	I _s /I _N	T _N Nm	T _i /T _N				T _b /T _N
1500 r/min = 4 poles				400 V 50 Hz				CENELEC							
1.1	M3AA 90LB 4	3GAA092520---E	1435	83.7	83.7	81.7	0.78	2.4	6.6	7.3	2.9	3.2	0.0043	16	50
1.5	M3AA 90LD 4	3GAA092540---E	1435	84.2	84.1	81.9	0.76	3.3	7.0	9.9	3.1	3.5	0.0048	17	50
2.2	M3AA 100LC 4	3GAA102530---E	1450	86.4	86.2	84.1	0.79	4.6	7.3	14.4	2.8	3.4	0.009	25	54
3	M3AA 100LD 4	3GAA102540---E	1445	85.7	86.1	85.1	0.79	6.3	7.0	19.8	2.4	3.0	0.011	28	63
4	M3AA 112MB 4	3GAA112320---E	1445	86.7	86.5	85.2	0.75	8.8	7.3	26.4	3.1	3.4	0.0126	34	64
5.5	M3AA 132M 4	3GAA132300---E	1465	89.0	89.5	88.6	0.79	10.9	6.3	36.0	1.9	2.6	0.038	48	66
7.5	M3AA 132MA 4	3GAA132310---E	1460	88.7	89.5	89.0	0.79	14.7	6.4	49.0	1.8	2.6	0.048	59	63
11	M3AA 160MLA 4	3GAA162410---G	1466	90.4	91.6	91.4	0.84	20.9	6.8	71.6	2.2	2.8	0.081	99	62
15	M3AA 160MLB 4	3GAA162420---G	1470	91.4	92.4	92.2	0.83	28.5	7.1	97.4	2.6	3.0	0.099	118	62
18.5	M3AA 180MLA 4	3GAA182410---G	1477	91.9	92.9	92.7	0.84	34.5	7.2	119	2.6	2.9	0.166	146	62
22	M3AA 180MLB 4	3GAA182420---G	1475	92.3	93.3	93.2	0.84	40.9	7.3	142	2.6	3.0	0.195	163	62
30	M3AA 200MLA 4	3GAA202410---G	1480	93.2	94.0	93.7	0.84	55.2	7.4	193	2.8	3.0	0.309	218	63
37	M3AA 225SMA 4	3GAA222210---G	1479	93.4	93.9	93.4	0.84	68.0	7.1	238	2.6	2.9	0.356	240	66
45	M3AA 225SMB 4	3GAA222220---G	1480	93.9	94.3	93.9	0.85	81.3	7.5	290	2.8	3.2	0.44	273	66
55	M3AA 250SMA 4	3GAA252210---G	1480	94.4	94.9	94.6	0.85	98.9	7.0	354	2.6	2.9	0.765	314	67
70	M3AA 280SMA 4	3GAA282210---G	1479	94.3	94.4	93.9	0.84	130	7.5	451	3.0	3.2	0.866	389	67
77	¹⁾ M3AA 280SMB 4	3GAA282220---G	1481	94.7	94.7	94.0	0.81	147	8.7	496	3.7	4.0	0.941	418	67

¹⁾ Temperature rise class F.

Equipment protection level and equipment group subdivision must be selected when ordering by choosing appropriate variant code:

Sizes 90-132

334 Ex t, Dust group III B T125C Db, IP6X (non-conductive dust) acc. IEC/EN60079-31

335 Ex t, Dust group III B T125C Dc, IP5X (non-conductive dust) acc. IEC/EN60079-31

336 Ex t, Dust group III C T125 Db, IP6X (conductive dust) acc. IEC/EN60079-31

337 Ex t, Dust group III C T125 Dc, IP6X (conductive dust) acc. IEC/EN60079-31

Sizes 160-280

340 Ex t, Dust group III B T125C Dc (non-conductive dust) with manufacturers declaration

Technical data for Ex t IIIB/IIIC IE2 aluminum motors, 1500 r/min

IP 55 - IC 411 - Insulation class F, temperature rise class B
IE2 efficiency class according to IEC 60034-30-1; 2014

Output kW	Motor type	Product code	Speed r/min	Efficiency IEC 60034-30-1; 2014			Power factor Cosφ	Current			Torque		Moment of inertia J = 1/4 GD ² kgm ²	Weight kg	Sound pressure Level L _{PA} dB
				Full load 100%	3/4 load 75%	1/2 load 50%		I _N A	I _s /I _N	T _N Nm	T _i /T _N	T _b /T _N			
1500 r/min = 4 poles				400 V 50 Hz				High-output							
18.5	M3AA 160MLC 4	3GAA162430-...G	1469	91.4	92.5	92.3	0.84	34.7	7.6	120	3.0	3.2	0.11	127	62
22	¹⁾ M3AA 160MLD 4	3GAA162440-...G	1464	91.6	92.6	92.7	0.85	41.3	6.9	143	2.5	2.9	0.125	140	62
28	¹⁾ M3AA 180MLC 4	3GAA182430-...G	1476	92.4	92.8	92.4	0.82	54.2	7.8	181	2.9	3.1	0.217	177	62
37	M3AA 200MLB 4	3GAA202420-...G	1479	93.4	94.4	94.4	0.85	67.2	7.1	238	2.6	2.9	0.343	234	63
42.5	¹⁾ M3AA 200MLC 4	3GAA202430-...G	1480	93.7	93.9	93.2	0.82	80.1	7.9	274	3.1	3.4	0.366	246	63
55	¹⁾ M3AA 225SMC 4	3GAA222230-...G	1478	94.0	94.7	94.5	0.85	99.3	7.4	355	2.9	3.1	0.474	287	66
58	M3AA 225SMD 4	3GAA222240-...G	1482	94.3	94.2	93.1	0.83	108	8.8	376	3.6	3.6	0.542	314	66
69	¹⁾ M3AA 250SMB 4	3GAA252220-...G	1480	94.4	94.6	94.1	0.84	126	7.8	445	3.0	3.4	0.866	350	67
77	¹⁾ M3AA 250SMC 4	3GAA252230-...G	1481	94.7	94.7	94.0	0.81	145	8.4	496	3.6	3.9	0.941	377	67

¹⁾ Temperature rise class F.

Equipment protection level and equipment group subdivision must be selected when ordering by choosing appropriate variant code:

Sizes 90-132

334 Ex t, Dust group III B T125C Db, IP6X (non-conductive dust) acc. IEC/EN60079-31

335 Ex t, Dust group III B T125C Dc, IP5X (non-conductive dust) acc. IEC/EN60079-31

336 Ex t, Dust group III C T125 Db, IP6X (conductive dust) acc. IEC/EN60079-31

337 Ex t, Dust group III C T125 Dc, IP6X (conductive dust) acc. IEC/EN60079-31

Sizes 160-280

340 Ex t, Dust group III B T125C Dc (non-conductive dust) with manufacturers declaration

Technical data for Ex t IIIB/IIIC IE2 aluminum motors, 1000 r/min

IP 55 - IC 411 - Insulation class F, temperature rise class B
IE2 efficiency class according to IEC 60034-30-1; 2014

Output kW	Motor type	Product code	Speed r/min	Efficiency IEC 60034-30-1; 2014			Power factor Cosφ	Current			Torque		Moment of inertia J = 1/4 GD ² kgm ²	Weight kg	Sound pressure Level L _{PA} dB
				Full load 100%	3/4 load 75%	1/2 load 50%		I _N A	I _s /I _N	T _N Nm	T _i /T _N	T _b /T _N			
1000 r/min = 6 poles				400 V 50 Hz				CENELEC							
0.75	M3AA 90LB 6	3GAA093520-...E	930	77.6	78.0	75.6	0.71	1.96	4.0	7.7	2.0	2.3	0.0048	18	44
1.1	M3AA 90LD 6	3GAA093540-...E	935	78.2	79.2	77.5	0.66	2.9	4.2	11.2	2.2	2.6	0.0056	20	44
1.5	M3AA 100LC 6	3GAA103530-...E	945	80.3	81.4	80.7	0.73	3.6	3.9	15.1	1.7	2.0	0.009	26	49
2.2	M3AA 112MB 6	3GAA113320-...E	955	81.9	81.8	79.2	0.72	5.3	5.2	21.9	1.8	2.2	0.01	34	56
3	M3AA 132S 6	3GAA133100-...E	960	83.3	82.9	80.5	0.65	7.7	4.3	29.8	1.6	2.3	0.031	46	57
4	M3AA 132MB 6	3GAA133320-...E	975	86.4	85.8	83.1	0.70	9.4	7.3	39.2	2.1	4.4	0.045	54	57
5.5	M3AA 132MC 6	3GAA133330-...E	965	86.1	85.6	83.0	0.67	13.3	6.2	54.3	2.5	2.8	0.049	59	61
7.5	M3AA 160MLA 6	3GAA163410-...G	975	88.5	89.8	89.7	0.79	15.4	7.4	73.4	1.7	3.2	0.087	98	59
11	M3AA 160MLB 6	3GAA163420-...G	972	89.3	90.6	90.5	0.79	22.5	7.5	108	1.9	2.9	0.114	125	59
13.5	M3AA 180MLA 6	3GAA183410-...G	979	90.7	90.7	89.4	0.75	29.1	6.3	131	2.0	3.0	0.168	148	59
18.5	M3AA 200MLA 6	3GAA203410-...G	988	91.6	92.3	91.7	0.80	36.4	6.7	178	2.3	2.9	0.382	196	63
22	M3AA 200MLB 6	3GAA203420-...G	987	92.0	92.9	92.8	0.82	42.0	6.6	212	2.2	2.8	0.448	218	63
30	M3AA 225SMA 6	3GAA223210-...G	986	92.6	93.3	92.8	0.83	56.2	7.0	290	2.6	2.9	0.663	266	63
37	M3AA 250SMA 6	3GAA253210-...G	989	93.1	93.8	93.4	0.82	69.9	6.8	357	2.4	2.7	1.13	294	63
45	M3AA 280SMA 6	3GAA283210-...G	988	93.2	94.0	93.9	0.84	82.9	6.8	434	2.4	2.6	1.37	378	63
55	¹⁾ M3AA 280SMB 6	3GAA283220-...G	988	93.2	94.1	94.0	0.84	101	7.1	531	2.6	2.8	1.5	404	63

¹⁾ Temperature rise class F.

Equipment protection level and equipment group subdivision must be selected when ordering by choosing appropriate variant code:

Sizes 90-132

334 Ex t, Dust group III B T125C Db, IP6X (non-conductive dust) acc. IEC/EN60079-31

335 Ex t, Dust group III B T125C Dc, IP5X (non-conductive dust) acc. IEC/EN60079-31

336 Ex t, Dust group III C T125 Db, IP6X (conductive dust) acc. IEC/EN60079-31

337 Ex t, Dust group III C T125 Dc, IP6X (conductive dust) acc. IEC/EN60079-31

Sizes 160-280

340 Ex t, Dust group III B T125C Dc (non-conductive dust) with manufacturers declaration

Technical data for Ex t IIIB/IIIC IE2 aluminum motors, 1000 r/min

IP 55 - IC 411 - Insulation class F, temperature rise class B
IE2 efficiency class according to IEC 60034-30-1; 2014

Output kW	Motor type	Product code	Speed r/min	Efficiency IEC 60034-30-1; 2014			Power factor Cosφ	Current		Torque		Moment of inertia J = 1/4 GD ² kgm ²	Weight kg	Sound pressure Level L _{PA} dB	
				Full load 100%	3/4 load 75%	1/2 load 50%		I _N A	I _s /I _N	T _N Nm	T _i /T _N				T _b /T _N
1000 r/min = 6 poles				400 V 50 Hz				High-output							
14	M3AA 160MLC 6	3GAA163430-...G	971	89.7	90.0	88.9	0.75	30.1	7.7	137	1.9	3.9	0.131	138	59
16.5	M3AA 180MLB 6	3GAA183420-...G	978	90.9	91.2	90.2	0.77	34.0	6.4	161	1.9	3.0	0.198	162	59
30	¹⁾ M3AA 200MLC 6	3GAA203430-...G	985	92.0	93.1	92.9	0.83	56.7	6.9	290	2.3	2.8	0.531	245	63
37	M3AA 225SMB 6	3GAA223220-...G	985	93.1	94.0	94.0	0.83	69.1	6.6	358	2.3	2.6	0.821	300	63
42	¹⁾ M3AA 225SMC 6	3GAA223230-...G	990	92.8	93.2	92.9	0.82	80.9	6.8	406	2.5	2.8	0.821	300	63
45	¹⁾ M3AA 250SMB 6	3GAA253220-...G	989	93.4	94.1	93.9	0.83	83.7	7.0	434	2.5	2.7	1.369	341	63
53	¹⁾ M3AA 250SMC 6	3GAA253230-...G	988	93.3	93.6	93.1	0.84	99.1	7.3	511	2.7	2.9	1.5	367	63

¹⁾ Temperature rise class F.

Equipment protection level and equipment group subdivision must be selected when ordering by choosing appropriate variant code:

Sizes 90-132

334 Ex t, Dust group III B T125C Db, IP6X (non-conductive dust) acc. IEC/EN60079-31

335 Ex t, Dust group III B T125C Dc, IP5X (non-conductive dust) acc. IEC/EN60079-31

336 Ex t, Dust group III C T125 Db, IP6X (conductive dust) acc. IEC/EN60079-31

337 Ex t, Dust group III C T125 Dc, IP6X (conductive dust) acc. IEC/EN60079-31

Sizes 160-280

340 Ex t, Dust group III B T125C Dc (non-conductive dust) with manufacturers declaration

Technical data for Ex t IIIB/IIIC IE2 aluminum motors, 750 r/min

IP 55 - IC 411 - Insulation class F, temperature rise class B
IE2 efficiency class according to IEC 60034-30-1; 2014

Output kW	Motor type	Product code	Speed r/min	Efficiency IEC 60034-30-1; 2014			Power factor Cosφ	Current		Torque		Moment of inertia J = 1/4 GD ² kgm ²	Weight kg	Sound pressure Level L _{PA} dB	
				Full load 100%	3/4 load 75%	1/2 load 50%		I _N A	I _s /I _N	T _N Nm	T _i /T _N				T _b /T _N
750 r/min = 8 poles				400 V 50 Hz				CENELEC							
0.37	M3AA 90S 8	3GAA094100-...E	695	56.1	55.3	48.6	0.57	1.65	2.7	5.1	1.9	2.2	0.0032	13	52
0.55	M3AA 90L 8	3GAA094500-...E	700	61.7	59.7	52.2	0.52	2.3	3.0	7.5	2.3	2.6	0.0043	16	52
0.75	M3AA 100LA 8	3GAA104510-...E	720	70.7	67.1	59.9	0.47	3.2	3.9	9.9	2.5	3.3	0.0069	20	46
1.1	M3AA 100LB 8	3GAA104520-...E	695	76.0	74.9	70.9	0.66	3.1	3.4	15.1	1.7	2.2	0.0082	23	53
1.5	M3AA 112M 8	3GAA114300-...E	690	74.4	74.1	70.5	0.70	4.1	3.2	20.7	1.4	1.9	0.01	28	55
2.2	M3AA 132S 8	3GAA134100-...E	715	77.7	79.2	77.6	0.65	6.2	3.4	29.3	1.3	1.9	0.031	46	56
3	M3AA 132M 8	3GAA134300-...E	715	79.3	78.8	75.5	0.64	8.5	3.2	40.0	1.2	1.8	0.037	53	58
4	M3AA 160MLA 8	3GAA164410-...G	728	84.0	85.1	83.6	0.67	10.2	5.4	52.4	1.5	2.6	0.068	84	59
5.5	M3AA 160MLB 8	3GAA164420-...G	726	84.6	85.9	84.8	0.67	13.9	5.6	72.3	1.4	2.6	0.085	98	59
7.5	M3AA 160MLC 8	3GAA164430-...G	727	86.0	87.3	86.5	0.65	19.3	4.7	98.5	1.5	2.8	0.132	137	59
11 ¹⁾	M3AA 180MLA 8	3GAA184410-...G	731	86.9	88.5	87.9	0.67	27.3	4.4	143	1.8	2.6	0.214	175	59
15	M3AA 200MLA 8	3GAA204410-...G	737	89.5	90.8	90.3	0.74	32.4	5.3	194	2.0	2.4	0.45	217	60
18.5	M3AA 225SMA 8	3GAA224210-...G	739	90.0	91.1	90.6	0.73	40.1	5.2	239	2.0	2.3	0.669	266	63
22	M3AA 225SMB 8	3GAA224220-...G	738	90.5	91.4	91.0	0.74	46.8	5.5	284	2.0	2.3	0.722	279	63
30	M3AA 250SMA 8	3GAA254210-...G	742	91.2	91.8	91.1	0.71	66.0	5.8	386	2.6	2.4	1.4	340	63
37	M3AA 280SMA 8	3GAA284210-...G	740	92.2	93.0	92.6	0.74	78.1	5.6	477	2.4	2.3	1.5	403	67

¹⁾ Temperature rise class F.

Equipment protection level and equipment group subdivision must be selected when ordering by choosing appropriate variant code:

Sizes 90-132

334 Ex t, Dust group III B T125C Db, IP6X (non-conductive dust) acc. IEC/EN60079-31

335 Ex t, Dust group III B T125C Dc, IP5X (non-conductive dust) acc. IEC/EN60079-31

336 Ex t, Dust group III C T125 Db, IP6X (conductive dust) acc. IEC/EN60079-31

337 Ex t, Dust group III C T125 Dc, IP6X (conductive dust) acc. IEC/EN60079-31

Sizes 160-280

340 Ex t, Dust group III B T125C Dc (non-conductive dust) with manufacturers declaration

Technical data for Ex t IIIB/IIIC IE2 aluminum motors, 750 r/min

IP 55 - IC 411 - Insulation class F, temperature rise class B
IE2 efficiency class according to IEC 60034-30-1; 2014

Output kW	Motor type	Product code	Speed r/min	Efficiency IEC 60034-30-1; 2014			Power factor Cosφ	Current		Torque		Moment of inertia J = 1/4 GD ² kgm ²	Weight kg	Sound pressure Level L _{PA} dB	
				Full load 100%	3/4 load 75%	1/2 load 50%		I _N A	I _s /I _N	T _N Nm	T _i /T _N				T _b /T _N
750 r/min = 8 poles				400 V 50 Hz				High-output							
15	M3AA 200MLB 8	3GAA204420-**-G	796	90.4	90.5	89.0	0.69	34.5	6.3	193	2.6	2.8	0.53	245	60
18.5	M3AA 200MLB 8	3GAA204420-**-G	739	90.0	90.8	90.2	0.74	40.0	5.4	239	2.1	2.3	0.53	245	60
30 ¹⁾	M3AA 225SMC 8	3GAA224230-**-G	737	91.2	92.3	92.1	0.73	64.7	5.6	388	2.3	2.4	0.828	300	63
37	M3AA 250SMB 8	3GAA254220-**-G	740	91.7	92.8	92.5	0.73	78.9	5.4	477	2.6	2.3	1.5	367	67
41	M3AA 250SMC 8	3GAA254230-**-G	739	91.9	92.2	91.3	0.72	89.0	6.0	529	2.5	2.6	1.505	367	63

¹⁾ Temperature rise class F.

Equipment protection level and equipment group subdivision must be selected when ordering by choosing appropriate variant code:

Sizes 90-132

334 Ex t, Dust group III B T125C Db, IP6X (non-conductive dust) acc. IEC/EN60079-31

335 Ex t, Dust group III B T125C Dc, IP5X (non-conductive dust) acc. IEC/EN60079-31

336 Ex t, Dust group III C T125 Db, IP6X (conductive dust) acc. IEC/EN60079-31

337 Ex t, Dust group III C T125 Dc, IP6X (conductive dust) acc. IEC/EN60079-31

Sizes 160-280

340 Ex t, Dust group III B T125C Dc (non-conductive dust) with manufacturers declaration

Variant codes

Dust ignition protection aluminum motors

Variant codes specify additional options and features to the standard motor. The desired features are listed as three-digit variant codes in the motor order. Note also that there are variants that cannot be used together.

Most of the variant codes apply to IE2 and IE3 motors. However, confirm the availability of variants for IE motors with your ABB sales office before making an order.

Code/Variant, M3AA	Frame size											
	71	80	90	100	112	132	160	180	200	225	250	280
Administration												
529	Customer witnessed visual inspection of complete order line.	-	-	•	•	•	•	•	•	•	•	•
531	Sea freight packing	•	•	•	•	•	•	•	•	•	•	•
533	Wooden sea freight packing	-	-	-	-	-	-	-	-	-	-	•
Balancing												
417	Vibration acc. to Grade B (IEC 60034-14).	-	-	•	•	-	-	-	-	-	-	-
423	Balanced without key.	-	-	•	•	•	•	•	•	•	•	•
424	Full-key balancing	-	-	•	•	•	•	•	•	•	•	•
Bearings and Lubrication												
036	Transport lock for bearings.	-	-	•	•	•	•	•	•	•	•	•
039	Cold-resistant grease	•	•	•	•	•	•	○	○	○	○	○
040	Heat-resistant grease	•	•	•	•	•	•	○	○	-	-	-
041	Bearings regreasable via grease nipples.	-	-	•	•	•	•	•	•	•	•	○
043	SPM compatible nipples for vibration measurement	-	-	-	-	•	•	•	•	•	•	○
057	2RS bearings at both ends.	○	○	○	○	○	○	•	•	•	•	•
593	Bearings grease suitable for food and beverage industry.	•	•	•	•	•	•	•	•	•	•	•
795	Lubrication information plate	-	-	-	-	-	•	•	•	•	•	•
796	Grease nipples JIS B 1575 PT 1/8 Type A	-	-	-	-	•	•	•	•	•	•	•
797	Stainless steel SPM nipples	-	-	-	-	•	•	•	•	•	•	•
798	Stainless steel grease nipples	-	-	-	-	•	•	•	•	•	•	•
Branch standard designs												
178	Stainless steel / acid proof bolts.	•	•	•	•	•	•	•	•	•	•	•
209	Non-standard voltage or frequency, (special winding).	-	-	•	•	•	•	•	•	•	•	•
217	Cast iron D-end shield (on aluminum motor).	-	-	•	•	•	•	○	○	○	○	○
385	Paint free motor	-	-	•	•	•	•	-	-	-	-	-
425	Corrosion protected stator and rotor core.	•	•	•	•	•	•	•	•	•	•	•
Cooling system												
053	Metal fan cover.	○	○	○	○	○	○	○	○	○	○	○
068	Light alloy metal fan	○	○	○	○	○	○	○	○	○	○	○
075	Cooling method IC418 (without fan).	-	-	•	•	•	•	•	•	•	•	•
Documentation												
141	Binding 2D main dimension drawing.	•	•	•	•	•	•	•	•	•	•	•
536	Photos of manufactured motors	-	-	•	•	•	•	•	•	•	•	•
537	Advanced data sheet	-	-	•	•	•	•	•	•	•	•	•
777	Premium documentation package	-	-	•	•	•	•	•	•	•	•	•
Drain holes												
065	Plugged existing drain holes.	○	○	○	○	○	○	○	○	○	○	○
Earthing Bolt												
067	External earthing bolt.	○	○	○	○	○	○	○	○	○	○	○
Hazardous Environments												
334	Ex t, Dust group III B T125C Db, IP6X (non-conductive dust) acc. IEC/EN60079-31.	-	-	•	•	•	•	•	•	•	•	•
335	Ex t, Dust group III B T125C Dc, IP5X (non-conductive dust) acc. IEC/EN60079-31.	-	-	•	•	•	•	•	•	•	•	•
336	Ex t, Dust group III C T125 Db, IP6X (conductive dust) acc. IEC/EN60079-31.	-	-	•	•	•	•	•	•	•	•	•
337	Ex t, Dust group III C T125 Dc, IP6X (conductive dust) acc. IEC/EN60079-31.	-	-	•	•	•	•	•	•	•	•	•

○ = Included as standard | • = Available as option | - = Not applicable

		Frame size											
Code/Variant, M3AA		71	80	90	100	112	132	160	180	200	225	250	280
340	Ex t, Dust group III B T125C Dc (non-conductive dust) with manufacturers declaration	●	●	-	-	-	-	-	-	-	-	-	-
Heating elements													
450	Heating element, 100-120 V	●	●	●	●	●	●	●	●	●	●	●	●
451	Heating element, 200 - 240 V	●	●	●	●	●	●	●	●	●	●	●	●
Insulation system													
014	Winding insulation class H.	-	-	●	●	●	●	●	●	●	●	●	●
405	Special winding insulation for frequency converter supply.	-	-	●	●	●	●	●	●	●	●	●	●
Marine													
024	Fulfilling Bureau Veritas (BV) requirements, with certificate.	-	-	●	●	●	●	●	●	●	●	●	●
025	Fulfilling Det Norske Veritas (DNV) requirements, with certificate.	-	-	●	●	●	●	●	●	●	●	●	●
026	Fulfilling Lloyds Register of Shipping (LR) requirements, with certificate.	-	-	●	●	●	●	●	●	●	●	●	●
027	Fulfilling American Bureau of Shipping (ABS) requirements, with certificate.	-	-	●	●	●	●	●	●	●	●	●	●
049	Fulfilling Germanischer Lloyd (GL) requirements, with certificate.	-	-	●	●	●	●	●	●	●	●	●	●
050	Fulfilling Registro Italiano Navale (RINA) requirements, with certificate.	-	-	●	●	●	●	●	●	●	●	●	●
096	Fulfilling Lloyds Register of Shipping (LR) requirements, without certificate (non-essential duty only)	●	●	●	●	●	●	●	●	●	●	●	●
186	Fulfilling Det Norske Veritas (DNV) requirements, without certificate	●	●	●	●	●	●	●	●	●	●	●	●
481	Fulfilling Nippon Kaiji Kyokai (NK) requirements, with certificate.	-	-	●	●	●	●	●	●	●	●	●	●
483	Fulfilling China Classification Societies (CCS) requirements (Beijing), with certificate.	-	-	●	●	●	●	●	●	●	●	●	●
484	Fulfilling Korea Register of Shipping (KR) requirements, with certificate.	-	-	●	●	●	●	●	●	●	●	●	●
491	Fulfilling Nippon Kaiji Kyokai (NK) requirements, without certificate.	●	●	●	●	●	●	●	●	●	●	●	●
492	Fulfilling Registro Italiano Navale (RINA) requirements, without certificate.	●	●	●	●	●	●	●	●	●	●	●	●
493	Fulfilling China Classification Societies (CCS) requirements (Beijing), without certificate.	●	●	●	●	●	●	●	●	●	●	●	●
494	Fulfilling Korea Register of Shipping (KR) requirements, without certificate.	●	●	-	●	●	●	●	●	●	●	●	●
496	Fulfilling Bureau Veritas (BV) requirements, without certificate(non-essential duty only)	●	●	●	●	●	●	●	●	●	●	●	●
675	Fulfilling American Bureau of Shipping (ABS) requirements, without certificate (non-essential duty only)	●	●	●	●	●	●	●	●	●	●	●	●
676	Fulfilling Germanischer Lloyd (GL) requirements, without certificate (non-essential duty only)	●	●	●	●	●	●	●	●	●	●	●	●
Mounting arrangements													
008	IM 2101 foot/flange mounted, IEC flange, from IM 1001 (B34 from B3).	●	●	●	●	●	●	●	-	-	-	-	-
009	IM 2001 foot/flange mounted, IEC flange, from IM 1001 (B35 from B3).	●	●	●	●	●	●	●	●	●	●	●	●
047	IM 3601 flange mounted, IEC flange, from IM 3001 (B14 from B5).	●	●	●	●	●	●	●	-	-	-	-	-
048	IM 3001 flange mounted, IEC flange, from IM 3601 (B5 from B14).	●	●	-	-	-	-	-	-	-	-	-	-
066	Modified for specified mounting position differing from IM B3 (1001), IM B5 (3001), B14 (3601), IM B35 (2001), IM B34 (2101)	●	●	●	●	●	●	●	●	●	●	●	●
080	(IM 3001) Flange mounted, DIN A-flange.	-	-	●	●	-	-	-	-	-	-	-	-
090	(IM 2101) foot/flange mounted, DIN C-flange, from IM 1001 (B34 from B3).	-	-	●	●	-	-	-	-	-	-	-	-
091	(IM 2001) foot/flange mounted, DIN A-flange, from IM 1001 (B35 from B3).	-	-	●	●	-	-	-	-	-	-	-	-
093	IM 3601 flange mounted, IEC flange, from IM 1001 (B14 from B3).	-	-	●	●	●	-	-	-	-	-	-	-
200	Flange ring holder.	●	●	●	●	●	●	-	-	-	-	-	-
218	Flange ring FT 85.	●	●	●	-	-	-	-	-	-	-	-	-
219	Flange ring FT 100.	●	●	●	-	-	-	-	-	-	-	-	-
220	Flange ring FF 100.	●	●	●	-	-	-	-	-	-	-	-	-
223	Flange ring FF 115.	●	●	●	-	-	-	-	-	-	-	-	-
224	Flange ring FT 115.	●	●	●	-	-	-	-	-	-	-	-	-
226	Flange ring FF 130.	●	●	●	●	●	-	-	-	-	-	-	-
227	Flange ring FT 130.	●	●	●	●	●	-	-	-	-	-	-	-
229	Flange FT 130.	-	-	-	●	●	-	-	-	-	-	-	-
233	Flange ring FF 165.	-	●	●	●	●	-	-	-	-	-	-	-
234	Flange ring FT 165.	●	●	●	●	●	-	-	-	-	-	-	-
235	Flange FF 165.	-	-	●	-	-	-	-	-	-	-	-	-
236	Flange FT 165.	-	-	-	-	-	●	-	-	-	-	-	-
243	Flange ring FF 215.	-	-	-	-	●	●	-	-	-	-	-	-
244	Flange ring FT 215.	-	-	-	●	●	●	-	-	-	-	-	-
245	Flange FF 215.	-	-	-	●	●	-	-	-	-	-	-	-
255	Flange FF 265.	-	-	-	-	-	●	-	-	-	-	-	-
260	Flange FT 115.	-	-	●	-	-	-	-	-	-	-	-	-

○ = Included as standard | ● = Available as option | - = Not applicable

Code/Variant, M3AA	Frame size											
	71	80	90	100	112	132	160	180	200	225	250	280
313 IM 3601 flange mounted, IEC flange, from IM 2101 (B14 from B34).	-	-	•	•	•	-	-	-	-	-	-	-
314 IM 3001 flange mounted, IEC flange, from IM 2101 (B5 from B34).	-	-	•	•	•	-	-	-	-	-	-	-
317 IM 3601 flange mounted, IEC flange, from IM 2001 (B14 from B35).	-	-	•	•	•	-	-	-	-	-	-	-
Painting												
114 Special paint color, standard grade	•	•	•	•	•	•	•	•	•	•	•	•
Protection												
005 Protective roof	•	•	•	•	•	•	•	•	•	•	•	•
072 Radial seal at D-end. Not possible for 2-pole, 280 and 315 frames	•	•	•	•	•	•	•	•	•	•	•	•
Rating & instruction plates												
004 Additional text on std rating plate (max 12 digits on free text line).	-	-	•	•	•	•	•	•	•	•	•	•
098 Stainless rating plate.	•	•	•	•	•	•	•	•	•	•	•	•
126 Tag plate	-	-	•	•	•	•	•	•	•	•	•	•
135 Mounting of additional identification plate, stainless.	•	•	•	•	•	•	•	•	•	•	•	•
138 Mounting of additional identification plate, aluminium.	•	•	•	•	•	•	•	•	•	•	•	•
139 Additional identification plate delivered loose.	•	•	•	•	•	•	•	•	•	•	•	•
159 Additional plate with text "Made in"	•	•	•	•	•	•	•	•	•	•	•	•
160 Additional rating plate affixed.	-	-	•	•	•	•	•	•	•	•	•	•
161 Additional rating plate delivered loose.	•	•	•	•	•	•	•	•	•	•	•	•
163 Frequency converter rating plate. Rating data according to quotation.	-	-	•	•	•	•	•	•	•	•	•	•
270 Additional rating plate with standard data, delivered loose	•	•	•	•	•	•	•	•	•	•	•	•
Shaft & rotor												
069 Two shaft extensions according to catalog drawings.	-	-	•	•	•	•	•	•	•	•	•	•
070 Special shaft extension at D-End, standard shaft material	-	-	•	•	•	•	•	•	•	•	•	•
131 Motor delivered with half key (key not exceeding shaft diameter)	-	-	•	•	•	•	•	•	•	•	•	•
165 Shaft extension with open keyway	-	-	•	•	•	•	•	•	•	•	•	•
410 Shaft material stainless steel	-	-	•	•	•	•	•	•	•	•	•	•
591 Special shaft extension according to customer specification.	-	-	•	•	•	•	•	•	•	•	•	•
600 Special shaft extension at N-end, standard shaft material.	-	-	•	•	•	•	-	-	-	-	-	-
Standards and Regulations												
543 Australian MEPS	-	•	•	•	•	•	•	•	•	•	•	•
544 Australian HE MEPS	-	-	-	-	-	-	•	•	•	•	•	•
Stator winding temperature sensors												
121 Bimetal detectors, break type (NCC), (3 in series), 130 °C, in stator winding	•	•	•	•	•	•	•	•	•	•	•	•
122 Bimetal detectors, break type (NCC), (3 in series), 150 °C, in stator winding	•	•	•	•	•	•	•	•	•	•	•	•
123 Bimetal detectors, break type (NCC), (3 in series), 170 °C, in stator winding	•	•	•	•	•	•	•	•	•	•	•	•
124 Bimetal detectors, break type (NCC), (3 in series), 140 °C, in stator winding	-	-	-	-	-	-	•	•	•	•	•	•
125 Bimetal detectors, break type (NCC), (2x3 in series), 150 °C, in stator winding	-	•	•	•	•	•	•	•	•	•	•	•
127 Bimetal detectors, break type (NCC), (3 in series, 130 °C & 3 in series, 150 °C), in stator winding	•	•	•	•	•	•	•	•	•	•	•	•
321 Bimetal detectors, closing type (NO), (3 in parallel), 130°C, in stator winding.	-	-	•	•	•	•	-	-	-	-	-	-
322 Bimetal detectors, closing type (NO), (3 in parallel), 150°C, in stator winding.	-	-	•	•	•	•	-	-	-	-	-	-
323 Bimetal detectors, closing type (NO), (3 in parallel), 170°C, in stator winding.	-	-	•	•	-	-	-	-	-	-	-	-
325 Bimetal detectors, closing type (NO), (2x3 in parallel), 150°C, in stator winding.	-	-	•	•	•	•	-	-	-	-	-	-
327 Bimetal detectors, closing type (NO), (3 in parallel, 130°C & 3 in parallel, 150°C), in stator winding.	-	-	•	•	•	•	-	-	-	-	-	-
435 PTC - thermistors (3 in series), 130 °C, in stator winding	•	•	•	•	•	•	•	•	•	•	•	•
436 PTC - thermistors (3 in series), 150 °C, in stator winding	•	•	•	•	•	•	○	○	○	○	○	○
437 PTC - thermistors (3 in series), 170 °C, in stator winding	-	-	•	•	•	•	•	•	•	•	•	•
439 PTC - thermistors (2x3 in series), 150 °C, in stator winding	•	•	•	•	•	•	•	•	•	•	•	•
440 PTC - thermistors (3 in series, 110°C & 3 in series, 130°C), in stator winding.	-	-	•	•	•	•	-	-	-	-	-	-
441 PTC - thermistors (3 in series, 130 °C & 3 in series, 150 °C), in stator winding	•	•	•	•	•	•	•	•	•	•	•	•
442 PTC - thermistors (3 in series, 150 °C & 3 in series, 170 °C), in stator winding	-	-	•	•	•	•	•	•	•	•	•	•
445 Pt100 2-wire in stator winding, 1 per phase	-	-	•	•	•	•	•	•	•	•	•	•
446 Pt100 2-wire in stator winding, 2 per phase	-	-	-	-	-	-	•	•	•	•	•	•
Terminal box												
015 Motor supplied in D connection.	•	•	•	•	•	•	•	•	•	•	•	•

○ = Included as standard | • = Available as option | - = Not applicable

Code/Variant, M3AA	Frame size											
	71	80	90	100	112	132	160	180	200	225	250	280
021 Terminal box LHS (seen from D-end).	-	-	-	-	-	-	-	-	●	●	●	●
022 Cable entry LHS (seen from D-end).	-	-	-	-	-	-	○	○	●	●	●	●
180 Terminal box RHS (seen from D-end).	-	-	-	-	-	-	-	-	●	●	●	●
230 Standard metal cable gland.	-	-	●	●	●	●	●	●	●	●	●	●
731 Two standard metal cable glands.	-	-	-	●	●	●	●	●	●	●	●	●
Testing												
145 Type test report from a catalogue motor, 400V 50Hz.	●	●	●	●	●	●	●	●	●	●	●	●
146 Type test with report for one motor from specific delivery batch.	-	-	●	●	●	●	●	●	●	●	●	●
147 Type test with report for motor from specific delivery batch, customer witnessed.	-	-	●	●	●	●	●	●	●	●	●	●
148 Routine test report.	●	●	●	●	●	●	●	●	●	●	●	●
150 Customer witnessed testing. Specify test procedure with other codes.	-	-	●	●	●	●	●	●	●	●	●	●
221 Type test and multi-point load test with report for one motor from specific delivery batch.	-	-	-	-	-	●	●	●	●	●	●	●
222 Torque/speed test, type test and multi-point load test with report for one motor from specific delivery batch.	-	-	●	●	●	●	●	●	●	●	●	●
760 Vibration level test	-	-	●	●	●	●	●	●	●	●	●	●
762 Noise level test for one motor from specific delivery batch.	-	-	●	●	●	●	●	●	●	●	●	●
763 Noise spectrum test for one motor from specific delivery batch.	-	-	●	●	-	-	-	-	-	-	-	-
Variable speed drives												
701 Insulated bearing at N-end.	-	-	-	-	-	-	●	●	●	●	●	●
704 EMC cable entry.	-	-	●	●	●	●	●	●	●	●	●	●

○ = Included as standard | ● = Available as option | - = Not applicable

Mechanical design

Motor frame and drain holes

Motor frame

The motor frame is made of aluminum alloy. Frame size 90-180 have aluminum feet and sizes 200-280 have cast iron feet.

The bearing end shield of sizes 90-132 are made of aluminum, and those of 160 to 280 are made of cast iron.

Motors can be supplied for foot mounting, flange mounting, and combinations of these.

Drain holes

Dust ignition protection motors are provided with drain holes fitted with plugs as standard. The plugs are made of plastic material and delivered in closed position.

When mounting arrangement differs from foot mounted IM B3, mention variant code 066 when ordering to ensure the drain plug is mounted in the lowest position.

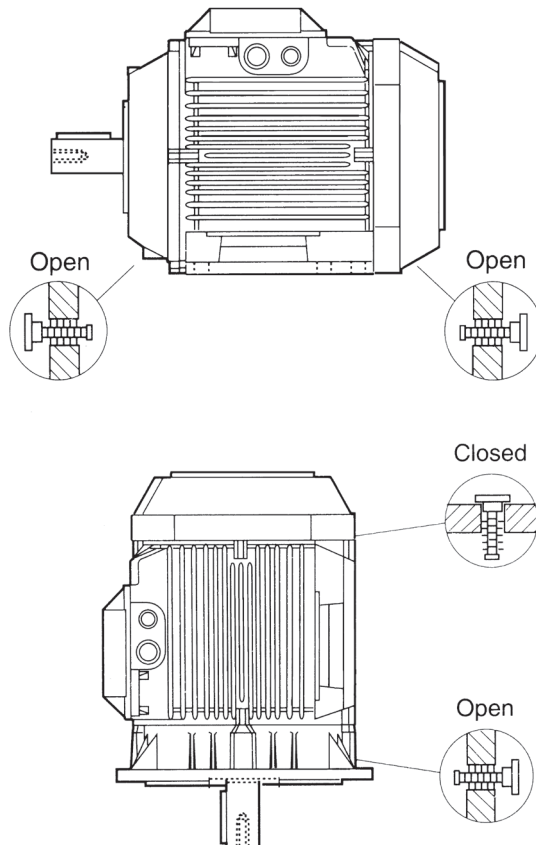

Mechanical design

Bearings

ABB's aluminum dust ignition protection motors are as standard fitted with single-row ball bearings according to the table below.

Lubrication

Motors in size 90-250 are delivered with greased for life shielded bearings as standard, as an option are also regreasable bearings with grease nipples available for sizes 160-250. Motors of size 280 are provided with regreasable bearings as standard.

Standard design: Deep groove ball bearings

Motor size	Foot and flange mounted motor	
	D-end	N-end
71	6203-2RSH/C3	6202-2RSH/C3
80	6204-2RSH/C3	6203-2RSH/C3
90	6205-2RSH/C3	6204-2RSH/C3
100	6306-2RS1/C3	6205-2RSH/C3
112	6306-2RS1/C3	6205-2RSH/C3
132	6208-2RS1/C3	6206-2RS1/C3
160	6309-2Z/C3	6209-2Z/C3
180	6310-2Z/C3	6209-2Z/C3
200	6312-2Z/C3	6210-2Z/C3
225	6313-2Z/C3	6212-2Z/C3
250	6315-2Z/C3	6213-2Z/C3
280	2-pole	6315/C3
280	4-8 pole	6316/C3

Axially-locked bearings

All motors with deep groove ball bearings are equipped as standard with an axially locked bearing at the D-end. For sizes 90-132 is the locking done by a spring washer at N-end pushing the rotor towards D-end.

Bearing seals

All motors have V-rings at both ends, motors in size 71-132 have in addition to the shaft seals 2RS type bearings with rubbers seals for improved protection.

Bearing life and lubrication

The nominal life L_{10h} of a bearing is defined according to ISO 281 as the number of operating hours achieved or exceeded by 90 % of identical bearings in a large test series under specified conditions. 50 % of bearings achieve at least five times this lifetime. The life time is dependent on various factors such as bearing load, motor speed, operating temperature and the purity of the grease. The permissible radial and axial loading for different motor sizes is shown in the tables on following pages.

The tables are valid for 50Hz.

Mechanical design

Radial forces

Pulley diameter

When the desired bearing life has been determined, the minimum permissible pulley diameter can be calculated with F_R as follows:

$$D = \frac{1.9 \cdot 10^7 \cdot K \cdot P}{n \cdot F_R}$$

Where:

D:	pulley diameter, mm
P:	power requirement, kW
n:	motor speed, r/min.
K:	belt tension factor, dependent on belt type and type of duty. A common value for V-belts is 2.5
F_R :	permissible radial force, refer to tables below.

Permissible loading on the shaft

The following table shows permissible radial forces on the shaft in Newtons, assuming zero axial force, a 25 °C ambient temperature, and normal conditions. The values are given for a calculated bearing life L_{10h} of 40 000 hours per motor size.

These calculated values further assume mounting position IM B3 (foot-mounted), with force directed sideways. In some cases, the strength of the shaft together with frame path dimensions affects permissible forces.

Permissible radial forces

Motor size	Poles	Length of shaft extension E (mm)	Ball bearings Basic design with deep groove ball bearings			
			25 000 hours		40 000 hours	
			F_{X0} (N)	F_{Xmax} (N)	F_{X0} (N)	F_{Xmax} (N)
71	2-8	30	680	570	680	570
80	2	40	630	750	930	750
80	4-8	40	930	750	930	750
90	2-8	50	1010	810	1010	810
100	2-8	60	2280	1800	2280	1800
112	2-8	60	2280	1800	2280	1800
132	2-8	80	2120	1610	2120	1610

Permissible loads of simultaneous radial and axial forces can be supplied on request.

If the radial force is applied between points X_0 and X_{max} , the permissible force F_R can be calculated with the following formula:

$$F_R = F_{X0} - \frac{X}{E} (F_{X0} - F_{Xmax})$$

Where:

E:	length of the shaft extension in the standard version
----	---

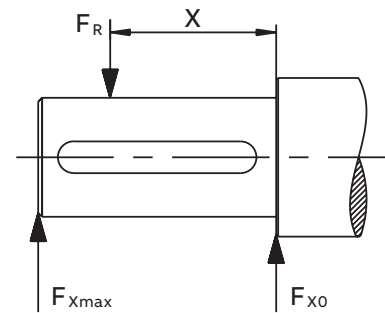

Permissible radial forces

			Ball bearings			
			Basic design with deep groove ball bearings			
Motor size	Poles	Length of shaft extension E (mm)	20 000 hrs		40 000 hrs	
			F_{x0} (N)	F_{xmax} (N)	F_{x0} (N)	F_{x0} (N)
160	2	110	4760	3860	4100	3320
	4	110	5180	4200	4380	3545
	6	110	5160	4180	4360	3540
	8	110	6280	4300	5320	4300
180	2	110	6060	4960	5280 ¹⁾	4305 ¹⁾
	4	110	4800	3940	4020	3300
	6	110	6280	5140	5280	4380
	8	110	6960	5500	5880	4800
200	2	110	7800	6500	6760 ²⁾	5640 ²⁾
	4	110	8400	7020	7180	5980
	6	110	8960	7480	7600	6340
	8	110	10480	8740	8940	7400
225	2	110	8520	7180	7360 ³⁾	6200 ³⁾
	4	140	8380	6780	7200	5820
	6	140	10 960	8860	9360	7560
	8	140	12 100	9780	10 340	8360
250	2	140	10 480 ⁴⁾	8500 ⁴⁾	9080 ⁴⁾	7360 ⁴⁾
	4	140	10 840	8780	9380	7600
	6	140	12 600	10 220	10 700	8680
	8	140	14 660	11 880	12 540	10 160
280	2	140	6780	5500	5680	4600
	4	140	8060	6540	6640	5380
	6	140	8980	7280	7360	5960
	8	140	9180	7460	7460	6060

¹⁾ The maximum lifetime of the grease is 38000 h

²⁾ The maximum lifetime of the grease is 27000 h

³⁾ The maximum lifetime of the grease is 23000 h

⁴⁾ The maximum lifetime of the grease is 16000 h

Mechanical design

Axial forces

01 Mounting arrangement IM B3.

02 Mounting arrangement IM V1.

The following tables present permissible axial forces on the shaft in Newtons, assuming zero radial force, a 25 °C ambient temperature, and normal conditions. The values are given for a calculated bearing life of 20,000 and 40,000 hours per motor size.

At 60 Hz, the values must be reduced by 10 percent, and for two-speed motors, the higher speed determines permissible axial force. Permissible loads of simultaneous radial and axial forces can be supplied on request.

For axial force F_{AD} , it is assumed that the D-bearing is locked with a locking ring.

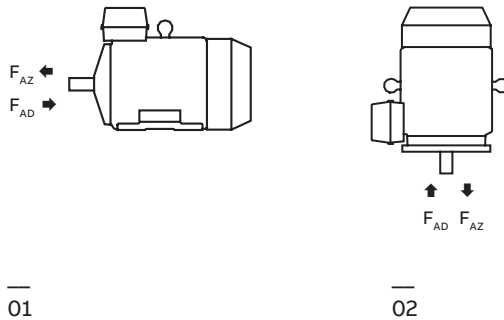

Permissible axial forces

Motor size	Poles	Mounting arrangement IM B3, deep groove ball bearings				Mounting arrangement IM V1, deep groove ball bearings			
		20 000 hours		40 000 hours		20 000 hours		40 000 hours	
		F_{AD} (N)	F_{AZ} (N)	F_{AD} (N)	F_{AZ} (N)	F_{AD} (N)	F_{AZ} (N)	F_{AD} (N)	F_{AZ} (N)
70	2	625	325	515	215	640	315	530	200
	4	780	480	630	330	800	470	650	320
	6	890	590	710	410	925	570	745	390
	8	985	685	780	480	1020	665	815	455
80	2	810	470	650	315	845	450	690	290
	4	1015	675	810	470	1075	640	865	430
	6	1170	830	925	595	1225	795	980	550
	8	1300	960	1015	675	1350	925	1070	645

¹⁾ The maximum lifetime of the grease is 38 000 h

²⁾ The maximum lifetime of the grease is 27 000 h

³⁾ The maximum lifetime of the grease is 23 000 h

⁴⁾ The maximum lifetime of the grease is 16 000 h

Permissible axial forces

Motor size	Poles	Mounting arrangement IM B3, deep groove ball bearings				Mounting arrangement IM V1, deep groove ball bearings			
		20 000 hours		40 000 hours		20 000 hours		40 000 hours	
		F _{AD} (N)	F _{AZ} (N)	F _{AD} (N)	F _{AZ} (N)	F _{AD} (N)	F _{AZ} (N)	F _{AD} (N)	F _{AZ} (N)
90	2	885	485	720	320	945	450	775	280
	4	1170	650	945	425	1245	600	1020	375
	6	1270	870	1005	605	1360	815	1095	550
	8	1410	1010	1110	710	1485	960	1185	660
100	2	1620	1120	1280	780	1710	1060	1370	715
	4	2065	1565	1615	1115	2180	1485	1735	1035
	6	2390	1890	1860	1360	2510	1815	1980	1285
	8	2660	2160	2065	1565	2780	2080	2185	1485
112 M, MB	2	1615	1115	1275	775	1725	1040	1385	700
	4	2060	1560	1610	1110	2210	1460	1110	1010
	6	2385	1885	1860	1360	2540	1785	2010	1260
	8	2655	2155	2060	1560	2790	2055	2195	1475
132 M, MA	4	2245	1645	1760	1160	2460	1505	1970	1015
	6	2595	1980	2025	1425	2815	1850	2245	1280
	8	2875	2270	2240	1640	3130	2115	2490	1470
132 MC	6	2580	1980	2010	1410	2885	1780	2315	1210
132 MBA	4	2235	1635	1750	1150	2495	1465	2010	980
132 S	6	2600	2000	2030	1435	2780	1885	2210	1315
	8	2885	2285	2245	1645	3100	2145	2460	1505
132 SB	2	1760	1160	1400	800	1910	1075	1540	705
132 SBB, SC	2	1760	1160	1395	795	1945	1045	1575	670
132 SMB, SMC	2	2210	1610	1740	1140	2435	1470	1950	985
	4	2840	2240	2205	1605	3150	2035	2515	1400
132 SMD	4	2830	2200	2230	1595	3195	1995	2560	1355
132 SME	2	2210	1610	1730	1130	2490	1425	2005	940
160	2	4160	4160	3425	3425	4560	3810	3860	3110
	4	4740	4740	3920	3920	5260	4310	4440	3490
	6	4840	4840	4000	4000	5400	4420	4540	3560
	8	5980	5980	4920	4920	6560	5580	5460	4480
180	2	5480	5480	4600 ¹⁾	4600 ¹⁾	5920	5115	5060 ¹⁾	4255 ¹⁾
	4	4360	4360	3540	3540	5080	3860	4240	3020
	6	5980	5980	4940	4630	6000	5445	5600	4385
	8	6000	6620	5460	5460	6000	6120	6000	4900
200	2	5000	6880	5000 ²⁾	5700 ²⁾	5000	6350	5000 ²⁾	5230 ²⁾
	4	5000	7660	5000	6340	5000	6950	5000	5650
	6	5000	8300	5000	6880	5000	7505	5000	6025
	8	5000	9880	5000	8160	5000	9215	5000	7435
225	2	5000	7380	5000 ³⁾	6120 ³⁾	5000	6770	5000 ³⁾	5490 ³⁾
	4	5000	7600	5000	6220	5000	6795	5000	5475
	6	5000	10140	5000	8420	5000	9270	5000	7490
	8	5000	11 420	5000	9460	5000	10 595	5000	8535
250	2	6000 ⁴⁾	9020 ⁴⁾	6000 ⁴⁾	7500 ⁴⁾	6000 ⁴⁾	8335 ⁴⁾	6000 ⁴⁾	6755 ⁴⁾
	4	6000	9800	6000	8040	6000	8820	6000	7120
	6	6000	11520	6000	9520	6000	10 275	6000	8235
	8	6000	13 700	6000	11 380	6000	12 645	6000	10 205
280	2	5260	5260	4220	4220	6400	4400	5420	3420
	4	6500	6500	5160	5160	7920	5400	6640	4120
	6	7500	7500	6040	6040	8500	6180	7840	4640
	8	7740	7740	6180	6180	8500	6435	7980	4775

¹⁾ The maximum lifetime of the grease is 38 000 h
²⁾ The maximum lifetime of the grease is 27 000 h
³⁾ The maximum lifetime of the grease is 23 000 h
⁴⁾ The maximum lifetime of the grease is 16 000 h

Terminal box

Protection and mounting

The degree of protection of the standard terminal box is IP55 or IP65 depending on the equipment protection level and dust category. It complies with the requirements of the protection method 't' dust ignition protection and prevents all ignition sources such as sparks, excessive over heating etc. All terminal box seals are of uninterrupted type fulfilling the requirements for Ex t motors. By default, terminal boxes are mounted on top of the motor at D-end.

Turnability

The terminal box of motors in size 90-180 are integrated with the frame which means that the box itself cannot be rotated. There are however cable entries both on RHS and LHS to allow cabling from either side. Motors in size 200-280 have a terminal box made of deep drawn steel mounted on top of the stator, the box itself cannot be rotated but there are two openings with detachable gland plates, one on RHS and another on LHS of the box allowing cable entry from both sides.

Cable entries

Terminal box is provided as standard with plugged holes for cable glands, no cable glands are included as standard, the knockout entry holes and cable flange holes are closed with Ex t approved blanking plugs.

Cable type and terminations

Terminations are suitable for copper cables. Cables are connected to terminals by cable lugs, the lugs are not included in the delivery.

Earthing bolts

The motors are as standard provided with at least one earthing bolt inside the terminal box and another on the frame. The earthing bolt on the frame is located on top close to the terminal box.

Terminal box

Terminal boxes and boards

01 Terminal box size 71 and 80.

02 Terminal box size 90-112.

03 Terminal box size 132.

04 Terminal box size 160 and 180.

05 Terminal box size 200-280.

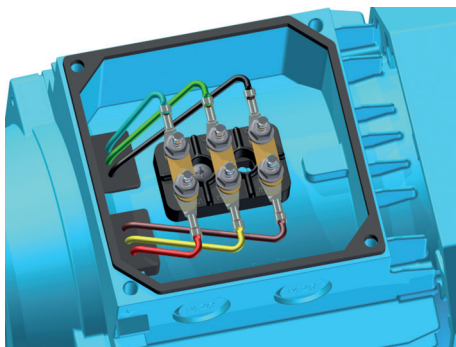

01

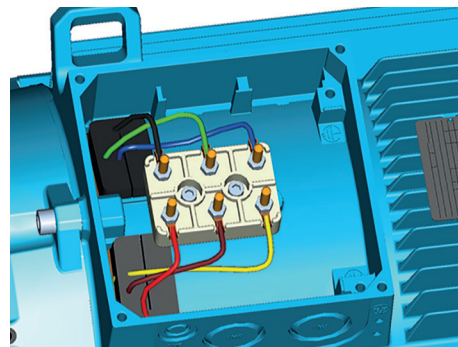

04

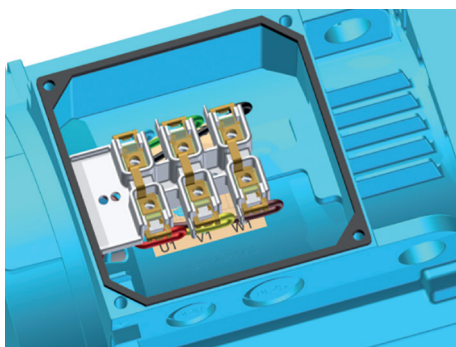

02

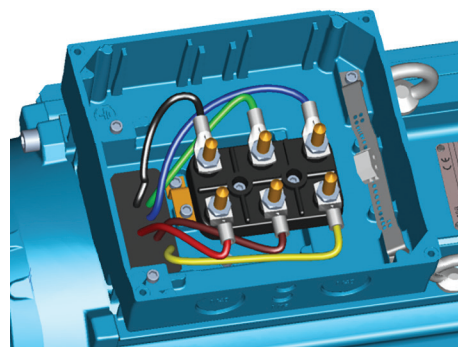

05

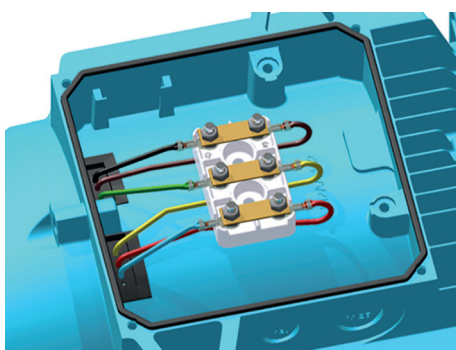

03

Motor size	Plugged cable entry	Terminal bolt size	Maximum connectable Cu-cable area, mm ²
71-80	2 x (2 x M20)	6 x M4	4
90-112	2 x (M25 + M20)	6 x M4 (screw)	6
132	2 x (M25 + M20)	6 x M5	10
160, 180	2 x (2 x M40) + M16	6 x M6	35
200-250	1 x (2 x M40 + M16)	6 x M10	70
280	1 x (2 x M63 + M16)	6 x M10	70

Dimension drawings

Dust ignition proof Ex t aluminum motors

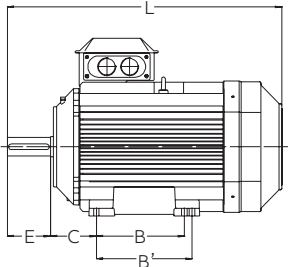

Foot-mounted motor IM 1001, IM B3

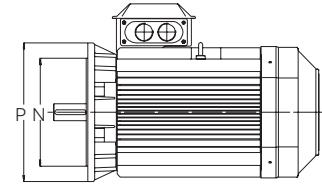
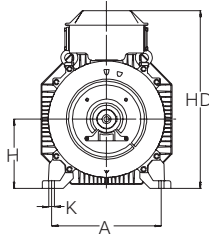

Flange-mounted motor IM 3001, IM B5

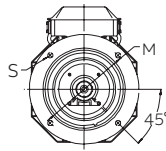
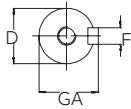

Sizes 90 to 200

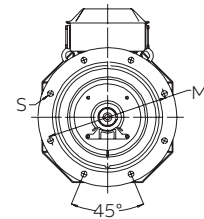

Sizes 225 to 250

Motor size	IM 1001, IM B3 AND IM 3001, IM B5										IM 1001, IM B3				IM3001, IM B5							
	D poles		GA poles		F poles		E poles		L max poles		O	A	B	B'	C	HD	K	H	M	N	P	S
	2	4-8	2	4-8	2	4-8	2	4-8	2	4-8												
M3AA 90S	24	24	27	27	8	8	50	50	288	288	30	140	100	-	56	217	10	90	165	130	200	12
90L	24	24	27	27	8	8	50	50	313	313	30	140	125	-	56	217	10	90	165	130	200	12
90LD	24	24	27	27	8	8	50	50	335	335	30	140	125	-	56	217	10	90	165	130	200	12
100	28	28	31	31	8	8	60	60	355	355	35	160	140	-	63	237	12	100	215	180	250	15
100LD	28	28	31	31	8	8	60	60	377	377	35	160	140	-	63	237	12	100	215	180	250	15
112	28	28	31	31	8	8	60	60	397	397	35	190	140	-	70	249	12	112	215	180	250	15
132 ¹⁾	38	38	41	41	10	10	80	80	458.5	458.5	50	216	140	178	89	296	12	132	265	230	300	14.5
132 ²⁾	38	38	41	41	10	10	80	80	498.5	498.5	50	216	140	178	89	321	12	132	265	230	300	14.5
160 ³⁾	42	42	45	45	12	12	110	110	584	584	50	254	210	254	108	370	15	160	300	250	350	19
160 ⁴⁾	42	42	45	45	12	12	110	110	681	681	50	254	210	254	108	370	15	160	300	250	350	19
180	48	48	51.5	51.5	14	14	110	110	726	726	55	279	241	279	121	405	15	180	300	250	350	19
200	55	55	59	59	16	16	110	110	821	821	55	318	267	305	133	532	18	200	350	300	400	19
225	55	60	59	64	16	18	110	140	850	880	60	356	286	311	149	579	18	225	400	350	450	19
250	60	65	64	69	18	18	140	140	884	884	65	406	311	349	168	627	22	250	500	450	550	19
280	65	75	69	79.5	18	20	140	140	884	884	65	457	368	419	190	627	24	280	500	450	550	19

¹⁾ All types except ²⁾

²⁾ SM_

³⁾ MLA 2, MLB 2, MLA 4, MLA 6, MLA 8 and MLB 8

⁴⁾ All remaining types, i.e. MLC 2, MLD 2, MLE 2, MLB 4, MLC 4, MLD 4 and MLC 8

⁵⁾ O = minimum free distance between fan cover air inlet and obstacle preventing airflow

IM 3601, IM B14

Motor size	LA	M	N	P	S	T
90	13	115	95	140	M8	3
100	14	130	110	160	M8	3.5
112	14	130	110	160	M8	3.5
132	18	165	165	200	M10	3.5

Tolerances		Tolerances	
A, B	ISO js14	F	ISO h9
C	± 0.8	H	-0,5
D	ISO k6 < Ø 50mm	N	ISO j6
	ISO m6 > Ø 50mm		

In all dimension drawings: The tables give the main dimensions in mm.

For detailed drawings please see our web-pages 'www.abb.com/motors&generators' or contact ABB.

Motors in brief

Dust ignition proof Ex t aluminum motors

Motor size	M3AA	71	80	90	100	112	132	160	180	200	225	250	280	
Stator and end shields	Material	Die cast aluminum alloy							Extruded aluminum alloy					
	Paint colour shade	Minsell blue 8B 4.5/3.25												
	Corrosion class	C3 medium according ISO/EN 12944-5												
Feet	Material	Integrated aluminum feet						Separate aluminum feet		Separate cast iron feet				
End shields	Material	Die cast aluminum alloy							Cast iron					
Bearings	D-end	6203-RSH/C3	6204-RSH/C3	6205-2RSH/C3	6306-2RS1/C3	6306-2RS1/C3	6208-2RS1/C3	6309-2Z/C3	6310-2Z/C3	6312-2Z/C3	6313-2Z/C3	6315-2Z/C3	6316/C3 ¹⁾	
	N-end	6202-RSH/C3	6203-RSH/C3	6204-2RSH/C3	6205-2RSH/C3	6205-2RSH/C3	6206-2RS1/C3	6209-2Z/C3	6209-2Z/C3	6210-2Z/C3	6212-2Z/C3	6213-2Z/C3	6213/C3	
Axially-locked bearings		Locked at D-end												
Bearing seal	D-end	V-ring			Gamma seal				V-ring					
	N-end	V-ring			Gamma seal				V-ring					
Lubrication		Permanently lubricated shielded bearing											Re-greasable	
Measuring nipples for condition monitoring of the bearings	Material	Not included		Optional										
Rating plate	Material	Aluminum												
Terminal box	Frame and cover	Die cast aluminum alloy, integrated in stator								Deep-drawn steel sheet, bolted on stator				
	Openings	2x (2x M20) plugged		2x (M25+M20) plugged				(2x M40 + M16) + (2x M40) plugged		2x M40 + M16 plugged			2x M63 + M16 plugged	
	Terminals	6 terminals												
Fan	Material	Aluminum												
Fan cover	Material	Steel												
Stator winding	Material	Copper												
	Insulation	Insulation class F												
	Winding protection	Optional						3 PCS PTC Thermistors						
Rotor winding	Material	Die cast aluminum												
Balancing method		Half key balancing												
Key way		Closed key way												
Drain holes		Drain holes with plastic plugs, closed.			Drain holes with closable plastic plugs, closed on delivery									
Enclosure		IP55			IP65 or IP55 depending on dust group and EPL.									
Cooling method		IC411			IC411									

¹⁾ 6315/C3 for 2-pole motors

Total product offering

Motors, generators and mechanical power transmission products with a complete portfolio of services



IEC motors

- Low voltage motors
- High voltage induction and synchronous motors
- Marine motors
- Motors for explosive atmospheres
- Motors for food and beverage
- Motors for variable speed drives
- Permanent magnet motors
- Synchronous reluctance motors
- Traction motors

NEMA motors

- Low voltage motors
- High voltage induction and synchronous motors
- Marine motors
- Motors for explosive atmospheres
- Motors for variable speed drives
- Permanent magnet motors
- Servomotors
- Washdown motors

Generators

- Generators for wind turbines
- Generators for diesel and gas engine power plants
- Generators for steam and gas turbine power plants
- Generators for marine applications
- Generators for industrial applications
- Generators for traction applications
- Synchronous condensers for reactive power compensation

Mechanical power transmission components, bearings, gearings

- Mounted bearings
- Enclosed gearing
- Mechanical drive components
- Couplings
- Sheaves and bushings
- Conveyor components
- Geared motor units

Life cycle services

ABB's portfolio of drives

Optimal solution for you



Being able to rely on the continuous high performance and efficiency of your operations is something you want to take for granted. ABB variable-frequency drives are made with all this in mind, established upon more than 40 years of experience and backed by a broad range of life cycle services.

ABB drives help you to optimize your processes and systems with state-of-the-art motor control technology, resulting in increased energy efficiency, better product quality, and reduced operating costs with higher output, less downtime, and reduced need for maintenance. All ABB drives are designed for easy selection, ordering, installation and use, and they offer integrated safety features, giving you more time to focus on what matters for you and your business.

Our portfolio offers low-voltage AC and DC drives, medium-voltage AC drives, and motion control drives spanning the fractional-kilowatt to multi-megawatt power level. There is a drive available for essentially every industry and application, which can be used with all types of motors, in environments ranging from clean electrical rooms in buildings, to harsh coal mines and windy offshore platforms. This wide product range allows you to select the best-fitting drive solution, providing maximum reliability and efficiency for every need.

Contact us



For more information and contact details:

www.abb.com/motors&generators